

Service.



Self-study programme 264

The Brake Assist System

Design and function

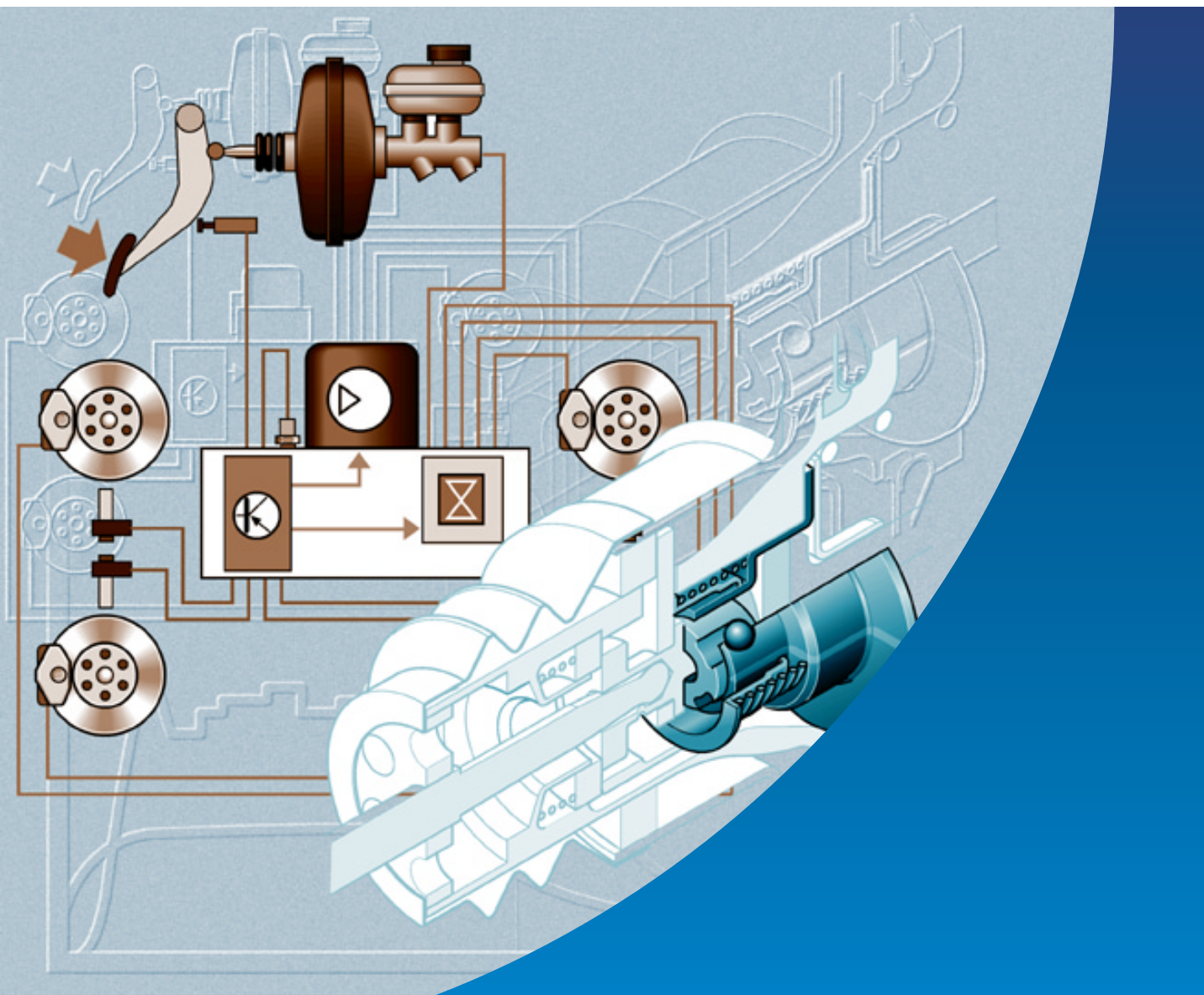

Accident statistics show that in 1999 alone, 493,527 accidents in Germany were caused by driver error. Many accidents caused by ignoring right-of-way, driving on the wrong side of the road, inappropriate speed, insufficient distance from other vehicles and so on might have been prevented had the vehicles been able to brake faster.

What does this mean?

Studies have shown that many drivers do not apply the brakes sufficiently in emergency situations due to lack of experience. That means that the greatest possible braking effect is not attained because the drivers did not press the brake pedal hard enough.

Therefore, the brake assist system was developed to support the driver in critical braking situations.

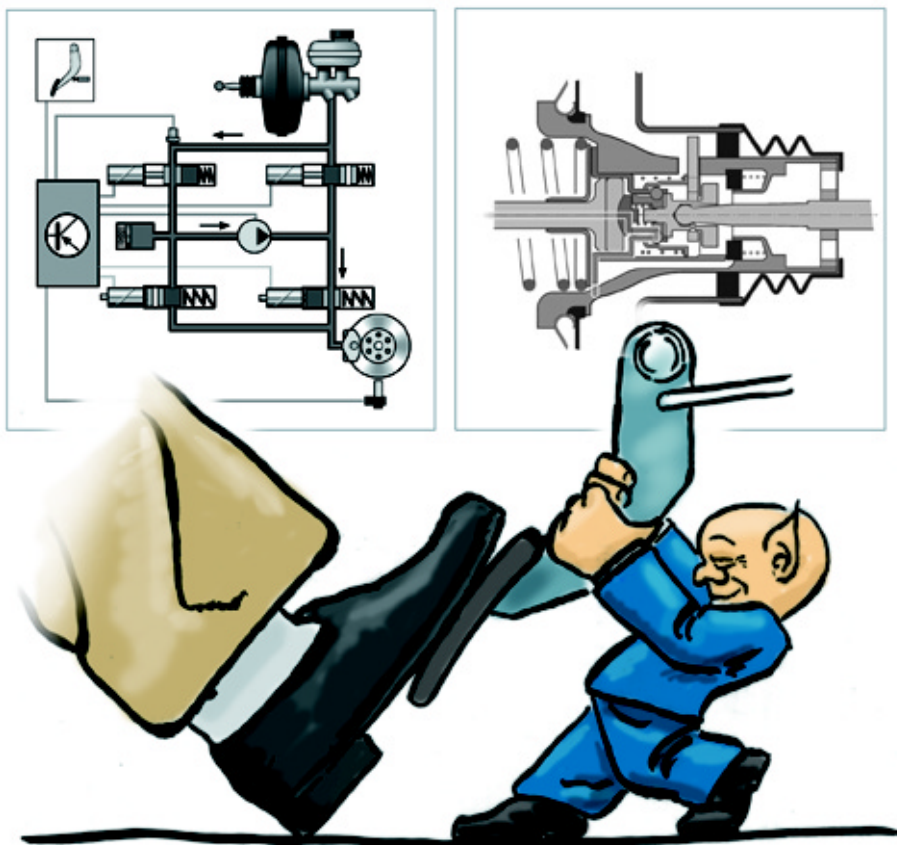

S264_042

New

Warning
Note



The self-study program presents the design and function of new technology. The contents will not be updated.

Please always refer to the relevant Service literature for all inspection, adjustment and repair instructions.

Table of contents



Introduction	4
The hydraulic brake assist system	8
Design, comparison and function	8
Electrical components	14
Functional diagram	19
The mechanical brake assist system	20
Design and function	20
Service	27
Test your knowledge	28



Introduction



Early in

automobile development, the brakes played a rather subordinate role because the friction in the drive train was so great that a vehicle was slowed sufficiently even without the brakes being used.

Increasing power and speed as well as constantly increasing traffic density led to the consideration in the 20s of how an appropriate brake system could provide a counterbalance to greater power and driving performance.

But only after advances in electronics and micro-electronics could systems be developed which could react fast enough in emergency situations.

The ancestor of the electronic brake systems is the ABS, which, since its introduction in 1978, has been continuously further developed and extended by additional functions. These functions intervene actively in the driving process to increase driving stability.

Currently, the trend in development is to driver support systems such as the brake assist system. The brake assist system supports the driver when braking in emergency situations to achieve the shortest possible brake path while maintaining steering ability.

1885 Mechanical brakes



1978 Active wheelspin control systems

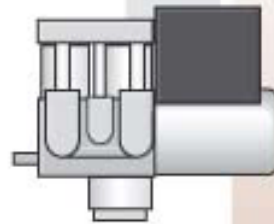

- ABS
- TCS
- EDL
- EBD
- EBC
- ESP

2000 Driver support systems



Brake assist system and future systems



What does the brake assist system do?

To answer this question, let's first take a look at a braking manoeuvre without a brake assist system.

A driver is surprised by the car in front of him braking suddenly. After a momentary shock, he recognises the situation and applies the brakes. Perhaps because he has not had to brake in critical situations very often and therefore has no feel for how hard he must brake, he does not press the pedal with all his might. Consequently, the greatest possible brake pressure will not be developed in the system and valuable braking distance is lost. The vehicle may not come to a stop in time.

In comparison, let's look at a car in the same situation but with a brake assist system.

As before, the brakes are not applied with sufficient force. Based on the speed and force with which the brake pedal is pressed, the brake assist system detects an emergency. The brake assist system increases the brake pressure until the ABS regulation intervenes to prevent the wheels from locking. This way the greatest possible braking effect can be achieved and the brake path can be shortened significantly.

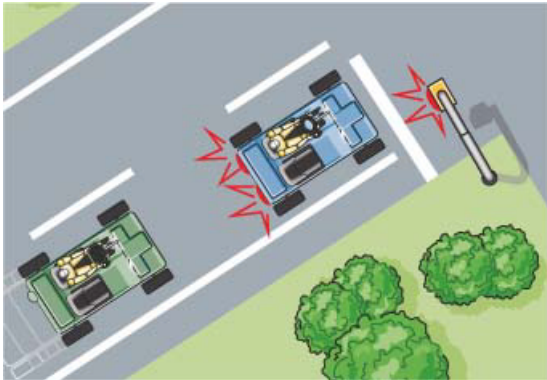

S264_005

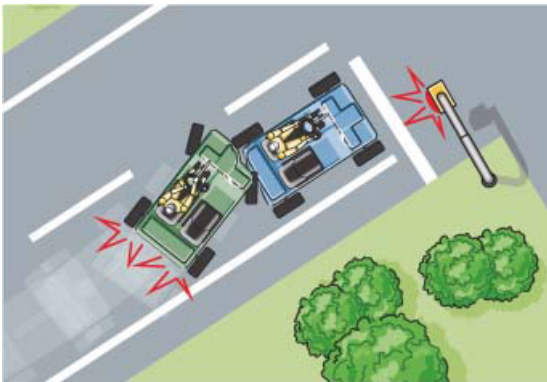

S264_006

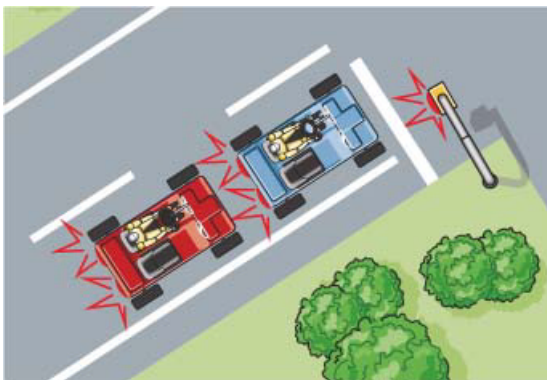

S264_008

Introduction



Depending on the manufacturer of the wheelspin regulation system, the developmental goal of a brake assist system was attained in different ways. Currently, we can distinguish between two different types:

- the hydraulic brake assist systems and
- the mechanical brake assist systems.

In hydraulic brake assist systems, like that from Bosch, the return flow pump of the ABS/ESP hydraulic system provides pressure, thus the expression „hydraulic brake assist system“. In this context, we speak of active pressure development.

The advantage in design is that no additional components needed to be integrated.

At VOLKSWAGEN, the hydraulic brake assist system is currently being used in the 2002 Polo, the 2001 Passat and the D-class vehicle.





In the mechanical brake assist systems from Continental-Teves, brake pressure is developed and an emergency situation is detected by mechanical components in the brake servo.

The mechanical brake assist system is being used in the current models of the Golf and Bora.

Both systems make use of existing system components to implement the function of the brake assist system. Therefore brake assist systems are currently available only in conjunction with ESP.

In this self-study programme, the differences in design and function between the hydraulic and mechanical brake assist systems will be described.



The hydraulic brake assist system

Design...

The central component in the Bosch brake assist system is the hydraulic unit with the integrated ABS control unit and the return flow pump. The brake pressure sender in the hydraulic unit, the speed sensors and the brake light switch supply signals to the brake assist system so that it can identify an emergency.

Pressure is raised in the brake slave cylinders by the actuation of certain valves in the hydraulic unit and the return flow pump for TCS/ESP.

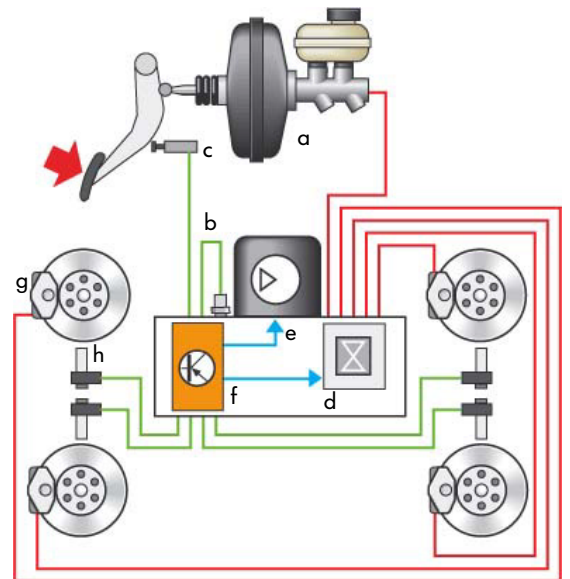

- a - Brake servo
- b - Brake pressure sensor
- c - Brake light switch
- d - Hydraulic unit
- e - Return flow pump
- f - Control unit
- g - Brake slave cylinder
- h - Speed sensor

... Comparison...

The vehicle without a brake assist system attains the ABS regulation range later than the vehicle with a brake assist system and consequently has a longer brake path.

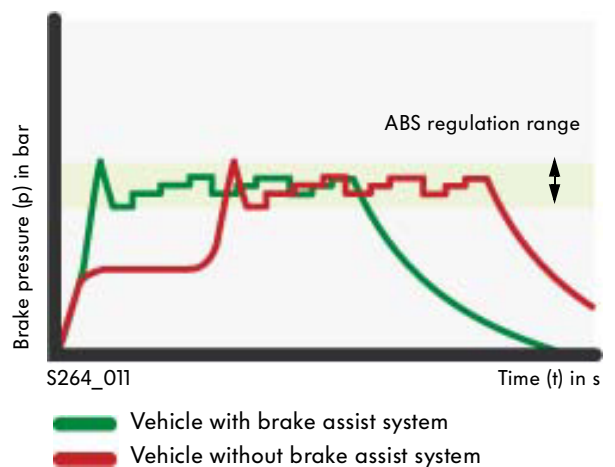

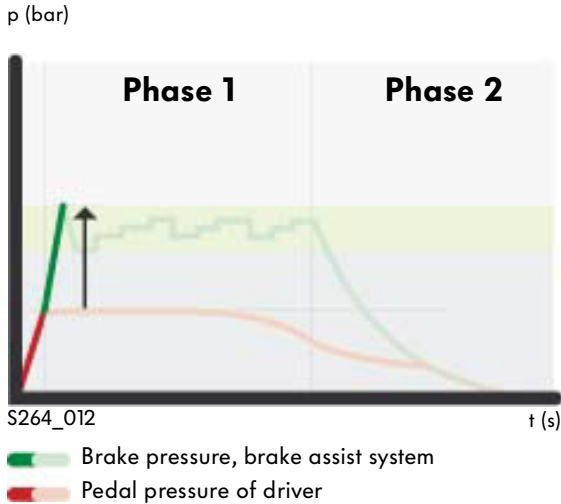

The brake assist system increases brake pressure until ABS regulation intervenes.

... and Function

The function of the brake assist systems can be divided into two phases:

- Phase 1 - Start of brake assist system intervention
- Phase 2 - Conclusion of brake assist system intervention

If the trigger conditions have been fulfilled, the brake assistance increases the brake pressure. The ABS regulation range is quickly attained through this active pressure increase.

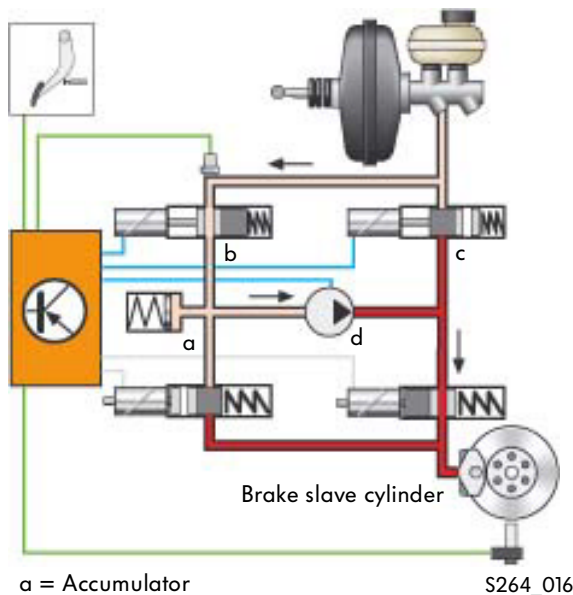

- a = Accumulator
- b = ESP (brake pressure) switch valve N225
- c = ESP high-pressure valve N227
- d = Return pressure valve

The electronic stability program switch valve N225 in the hydraulic unit is opened and the electronic stability program high-pressure valve N227 is closed. Consequently, the pressure created by the actuation of the return flow pump is directed immediately to the brake slave cylinders.

The hydraulic brake assist system

Phase 1

The function of the brake assist system is to increase the brake pressure as quickly as possible to the maximum value. The ABS function, which is supposed to prevent the wheels from locking, limits the pressure increase when the locking threshold is reached. That means that once the ABS intervention has begun, the brake assist system can not further increase the brake pressure.

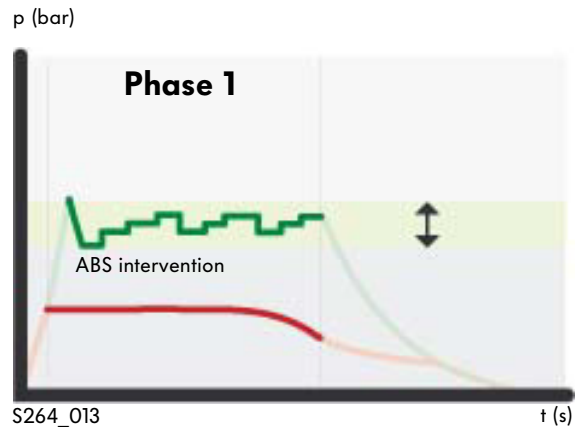

- █ Brake pressure at brake slave cylinder
- █ Pedal pressure of driver

When the ABS intervenes, the ESP (brake pressure) switch valve N225 is closed again and the ESP high-pressure valve N227 is opened. The discharge from the return flow pump keeps the brake pressure below the locking threshold.

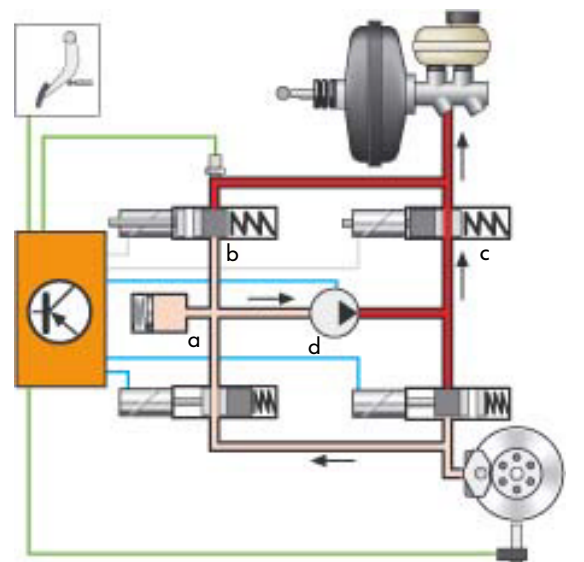

- a = Accumulator
- b = ESP (brake pressure) switch valve N225
- c = ESP high-pressure valve N227
- d = Return flow pump

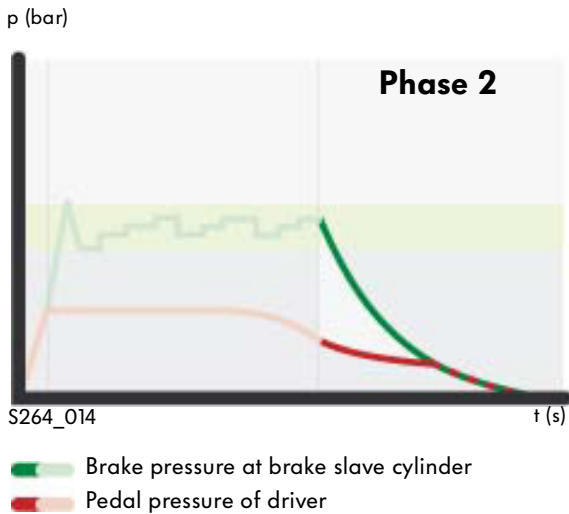

Phase 2

If the driver reduces the pressure on the brake pedal, the trigger conditions are no longer fulfilled. The brake assist system concludes that the emergency situation has been resolved and moves to phase 2. Now the pressure in the brake slave cylinders is adapted to the driver's pressure on the brake pedal. The transition from phase 1 to phase 2 occurs not with a jump but smoothly, with the brake assist system reducing its contribution to the pressure relative to the reduction of pressure on the brake pedal. When its contribution finally reaches zero, normal braking function is restored.

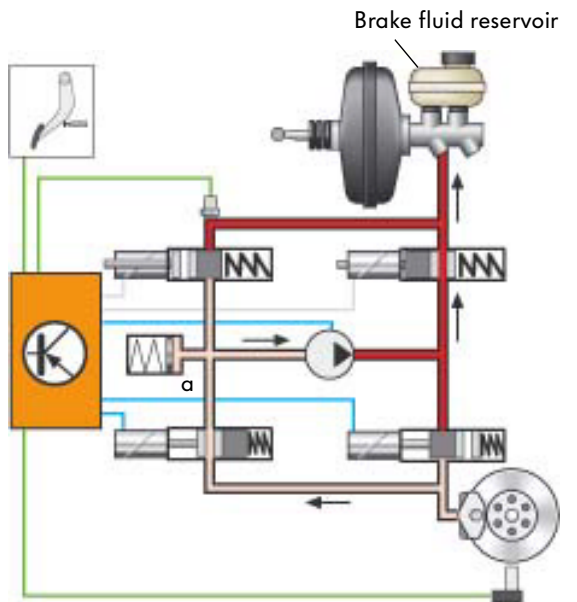

The brake pressure is reduced.

- a = Accumulator
- b = ESP (brake pressure) switch valve N225
- c = ESP high-pressure valve N227
- d = Return flow pump

The brake assist system also ends its intervention when the vehicle speed drops below a predefined value. In both cases, brake pressure is reduced by the actuation of the corresponding valves. Brake fluid can flow to the accumulator and is pumped back into the brake fluid reservoir by the return flow pump.

The hydraulic brake assist system

The trigger conditions

An emergency braking situation is identified by the following trigger conditions, triggering intervention by the brake assist system.

These conditions must be fulfilled:

1. The signal from brake light switch indicating that the brakes have been applied.
2. The signals from the speed sensors indicating how fast the vehicle is travelling.
3. The signal from the brake pressure sender indicating how fast and with what force the driver has applied the brakes.

The speed and force with which the brakes are applied are determined using the pressure development gradient in the brake master cylinder. That means that the control unit determines the change in current brake pressure via the pressure sensor in the hydraulic unit over a certain period of time. That is the pressure development gradient.

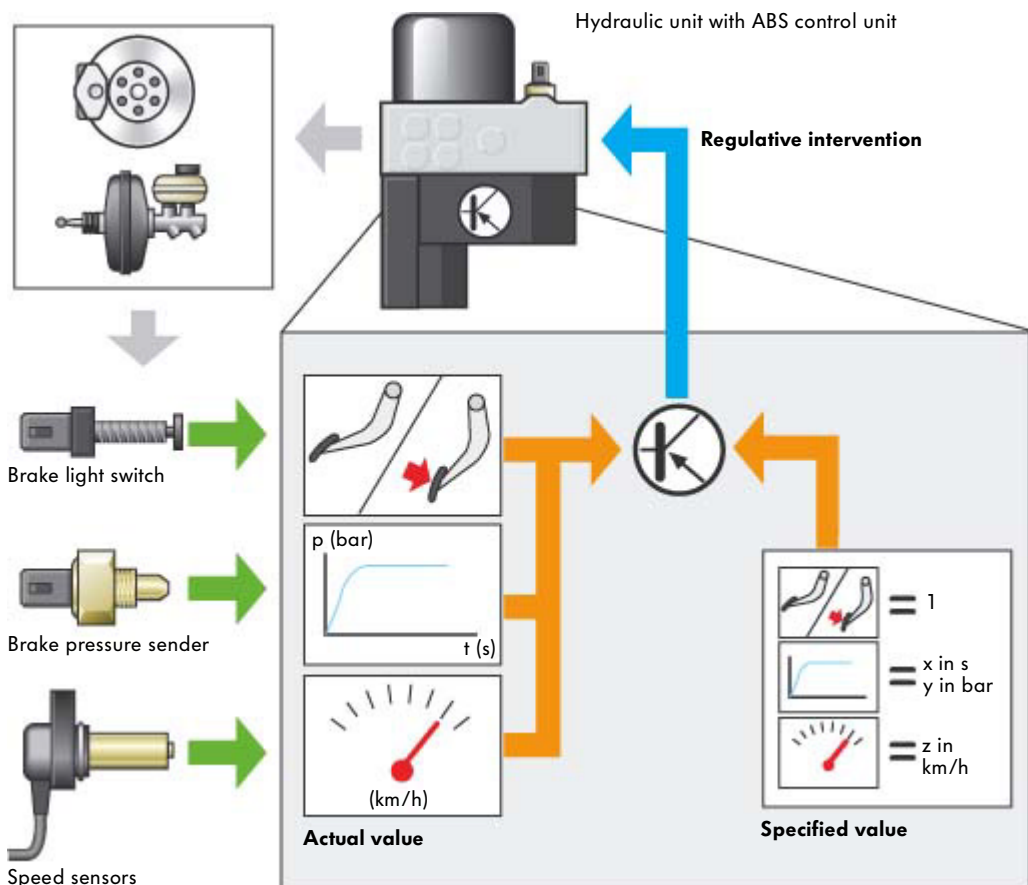

S264_020



The slope of the pressure curve is the determining factor for brake assist system intervention

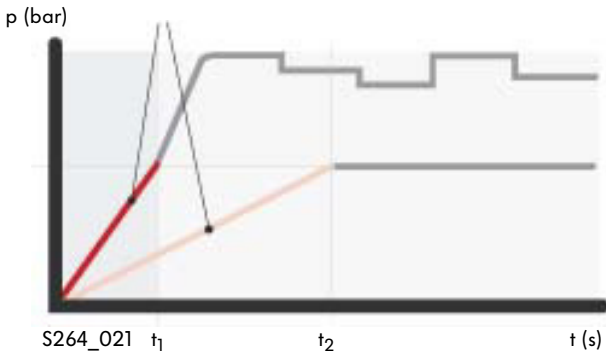

The intervention threshold for the brake assist system is a predefined value depending on the vehicle speed. If the brake pedal pressure exceeds this defined value in a period of time, the brake assist system initiates intervention. When the change in pressure drops below this threshold, the brake assist system ends its intervention.

In other words, if the pedal pressure reaches a certain value within a short period t_1 , the intervention conditions are fulfilled and the brake assist system intervenes. If the same pedal pressure is attained only after a longer time t_2 , the curve is flat and the brake assist system does not intervene. Thus, no intervention occurs if:

- the brake pedal is pressed to slowly or not at all,
- the change in pressure remains below the threshold,
- the vehicle speed is too low or
- the driver has applied the brakes with sufficient force.

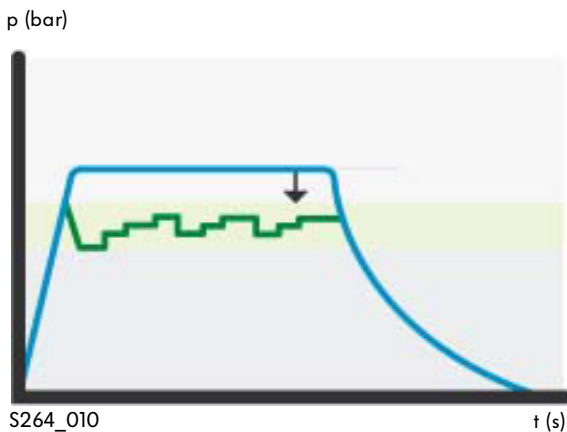

- Brake pressure with ABS intervention
- Pedal pressure of driver

An experienced driver develops sufficient pressure using the brake pedal and the brake servo. ABS prevents the wheels from locking.

The hydraulic brake assist system

Electrical components

Brake light switch F



The brake light switch is installed in the pedal cluster and detects the operation of the brake pedal.

- How it works

The brake light switch is a classic mechanical two-position push button.

- How the signal is used

The switch provides one of two signals: brake pedal pressed or brake pedal not pressed.

The signal from the brake light switch is used for the various brake systems, the engine management system and the switching on of the brake lights.

- Switch failure

The brake assist system is not functional without the brake light switch signal.

- Self-diagnosis

A switch defect will be detected by self-diagnosis and saved in the fault memory. If the switch is renewed, it must be adjusted according to the workshop manual.

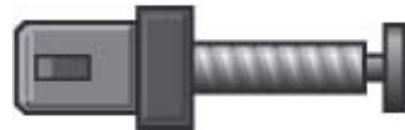

S264_025

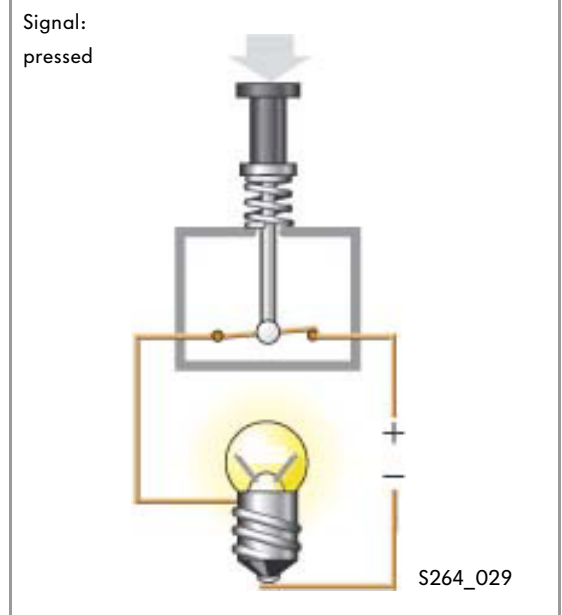
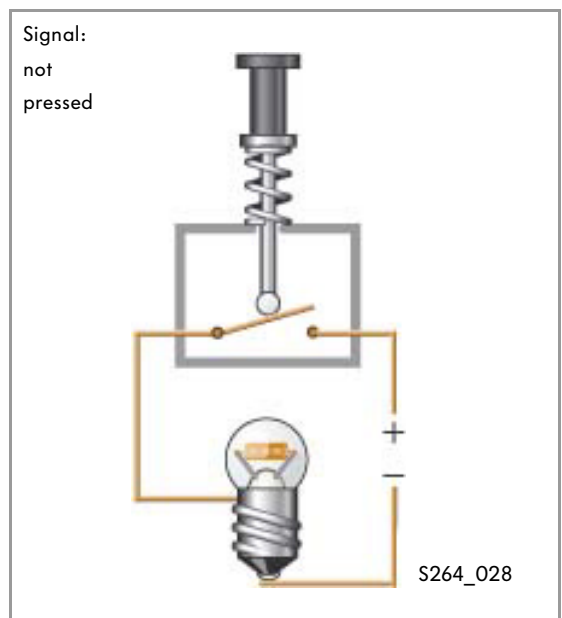



Brake pressure sender G201

If the brake system has ESP, the brake pressure sender is screwed directly into the hydraulic unit and senses the current pressure in the brake system.

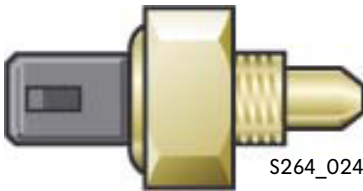

S264_024

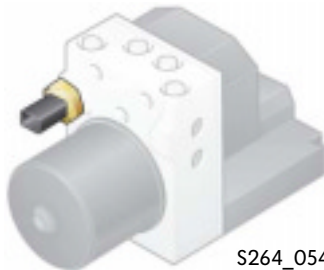

S264_054

● How it works

The heart of the sender is a piezo-electric element. It reacts to changes in pressure with a change in the charge distribution within the element, producing a measurable change in voltage.

Changes in the sender's voltage are detected and evaluated by the control unit.

● How the signal is used

As described above, the signal over a period of time is used to calculate a pressure gradient which defines the intervention conditions for the brake assist system.

● Sender failure

Neither the brake assist system nor the ESP is functional without the signal from the brake pressure sender.

● Self-diagnosis

A sender defect will be detected by self-diagnosis and saved in the fault memory.

Uniformly distributed charge

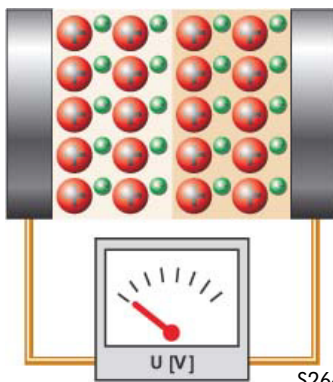

S264_026

Irregularly distributed charge

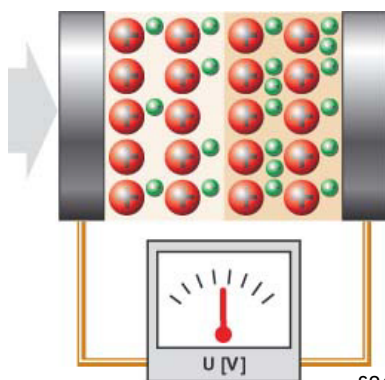

S264_027

The hydraulic brake assist system

Speed sensors G44 - G47

The speed sensors are inductive sensors which, using a rotor on each wheel hub as sender wheel, determine the current rotational speed of the wheels.

- How it works

The sensor consists of a soft iron core with a permanent magnet and a coil.

The magnetic field which the permanent magnet creates over the iron core is influenced by the sender wheel. Changes in the magnetic field induce measurable voltage in the sensor coil. The faster the sender wheel passes the coil, the higher the frequency of the voltage change.

- How the signal is used

The ABS control unit calculates the rotational speed of each wheel based on the frequency. The rotational speed of the wheels is used by a variety of different vehicle systems.

- Sensor failure

Without the speed sensor signal, the brake assist system cannot calculate the speed-dependent threshold. The brake assist system is switched off.

- Self-diagnosis

A defect in a speed sensor is detected by self-diagnosis and saved in the fault memory.

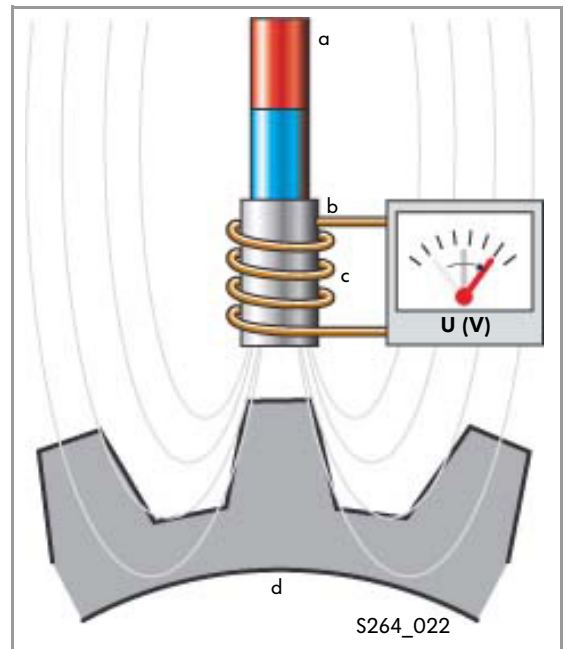
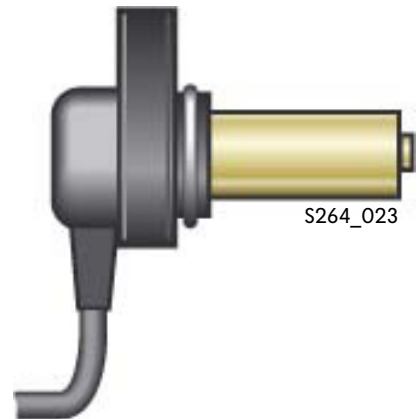

- a - Permanent magnet
- b - Soft iron core
- c - Coil
- d - Rotor

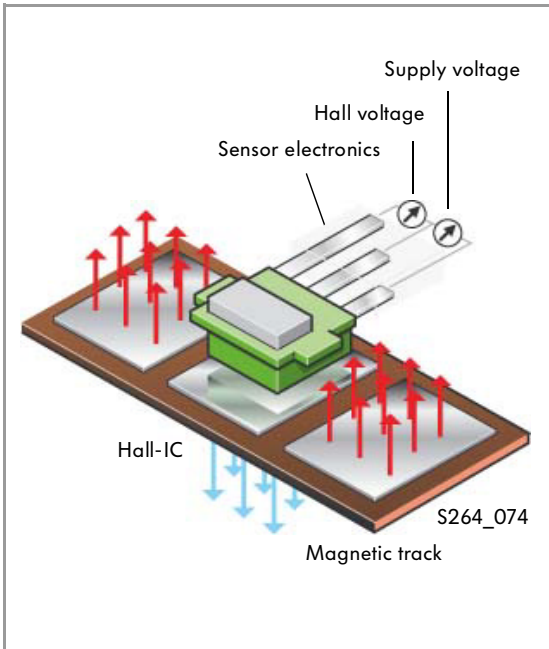
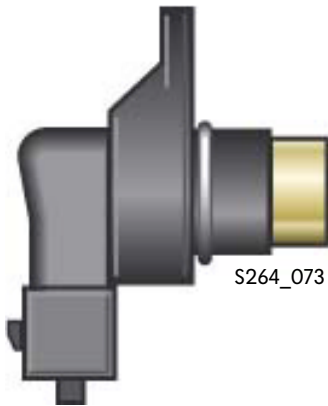

Active wheel sensing

There is another type of rotational speed sensors which are called active sensors and will be used with increasing frequency for determining wheel speeds. The term „active“ refers to the required voltage supply for the sensors, which is not necessary for inductive sensors.

- How it works

The heart of the sensor is a Hall integrated circuit (IC).

When current flows through this semi-conductor chip, a Hall voltage is created. Changes in the magnetic environment of the sensor cause proportional changes in the Hall voltage because the resistance in the Hall IC changes.

Depending on the version of the sensor, it can be paired with either a magnetic sender wheel or a sender wheel with a magnetic track.

As the sender wheel moves past the sensor, the magnetic environment and, consequently, the Hall voltage change.

- How the signal is used

The control unit can determine the rotational speed based on the frequency of changes in voltage.

With active sensors, even very low speeds can be detected.

- Self-diagnosis

A defect in a speed sensor is detected by self-diagnosis and saved in the fault memory.



The hydraulic brake assist system

ABS return flow pump V39

During ABS operation, the return flow pump returns a quantity of brake fluid against the pressure developed by the brake pedal and the brake servo.

● How it works

It is a double-acting piston hydraulic pump which can be switched on or off by the ABS control unit. In this case, „double acting“ means that with each piston stroke a suction and a discharge action are performed. With a single-acting piston, the two actions occur consecutively.

The double action is achieved through the design, which includes working chambers in front of and behind the piston. When the piston moves to the left, the front chamber is emptied and brake fluid is drawn into the back chamber. When the piston moves to the right, brake fluid is forced out of the back chamber back into the suction line. The pre-pressure on the suction side produces a nearly uniform discharge so that pressure can be built up quickly. An additional pump for building up pre-pressure is no longer necessary.

● Failure of return flow pump

Without the contribution of the return flow pump, many brake system functions like, for example ABS, fail. The brake assist system is likewise non-functional.

● Self-diagnosis

A defect in the return flow pump is detected by self-diagnosis and stored in the fault memory.

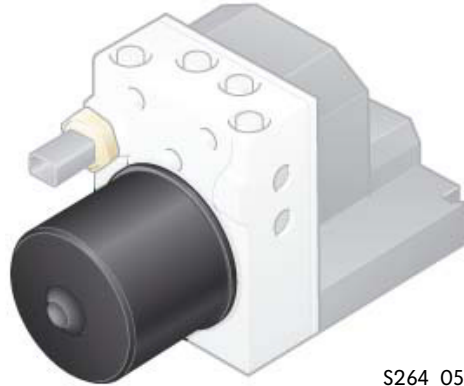

S264_053

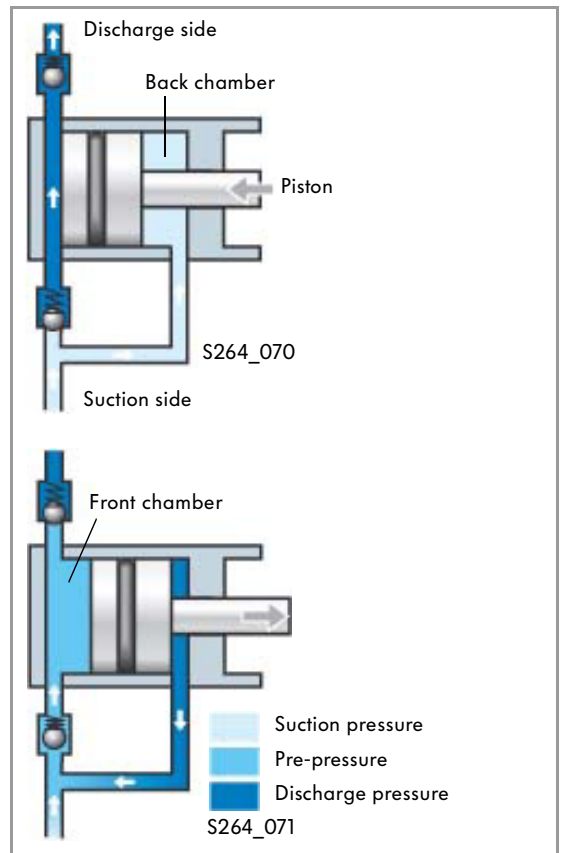

Functional diagram

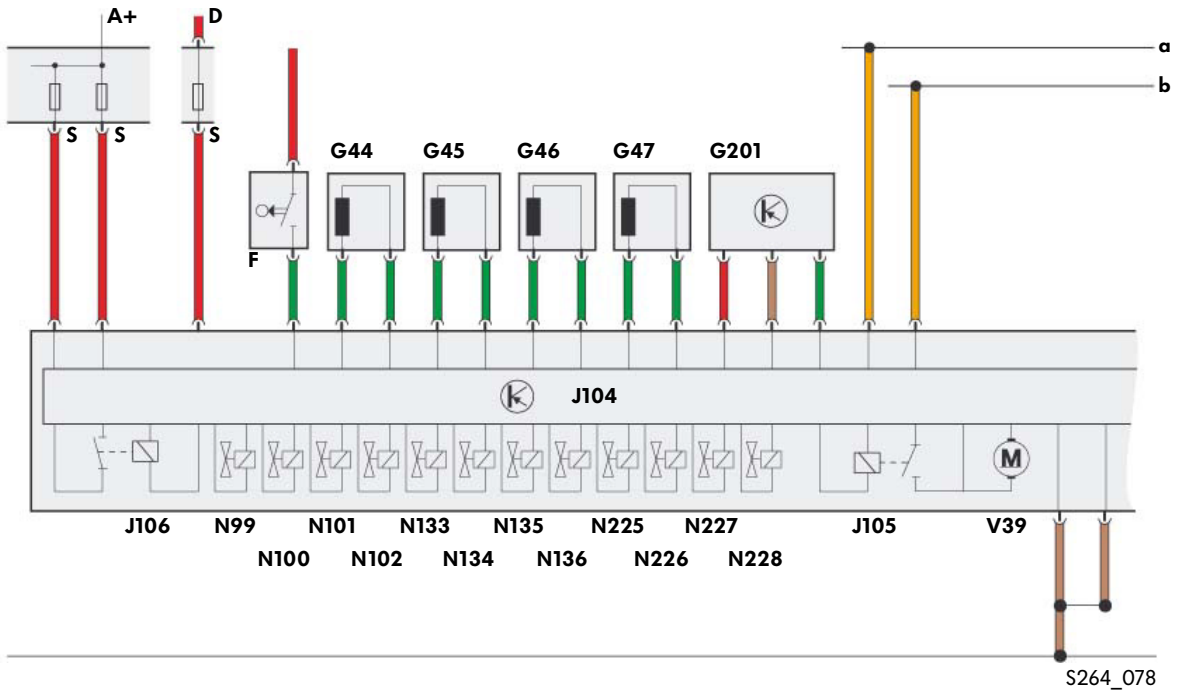

A+	Battery	N225	ESP switch valve -1-
D	Ignition/starter switch	N226	ESP switch valve -2-
F	Brake light switch	N227	ESP high-pressure valve -1-
		N228	ESP high-pressure valve -2-
G44	Rear right speed sensor	S	Fuse
G45	Front right speed sensor	V39	ABS return flow pump
G46	Rear left speed sensor	a	CAN high
G47	Front left speed sensor	b	CAN low
G201	Brake pressure sender		
J104	ABS control unit		
J105	ABS return flow pump relay		
J106	ABS solenoid valve relay		
N99	ABS inlet valve, front right		
N100	ABS outlet valve, front right		
N101	ABS inlet valve, front left		
N102	ABS outlet valve, front left		
N133	ABS inlet valve, rear right		
N134	ABS inlet valve, rear left		
N135	ABS outlet valve, rear right		
N136	ABS outlet valve, rear left		



The mechanical brake assist system

Design ...

The heart of the Continental-TEVES mechanical brake assist system is a mechanical switch component in the brake servo.

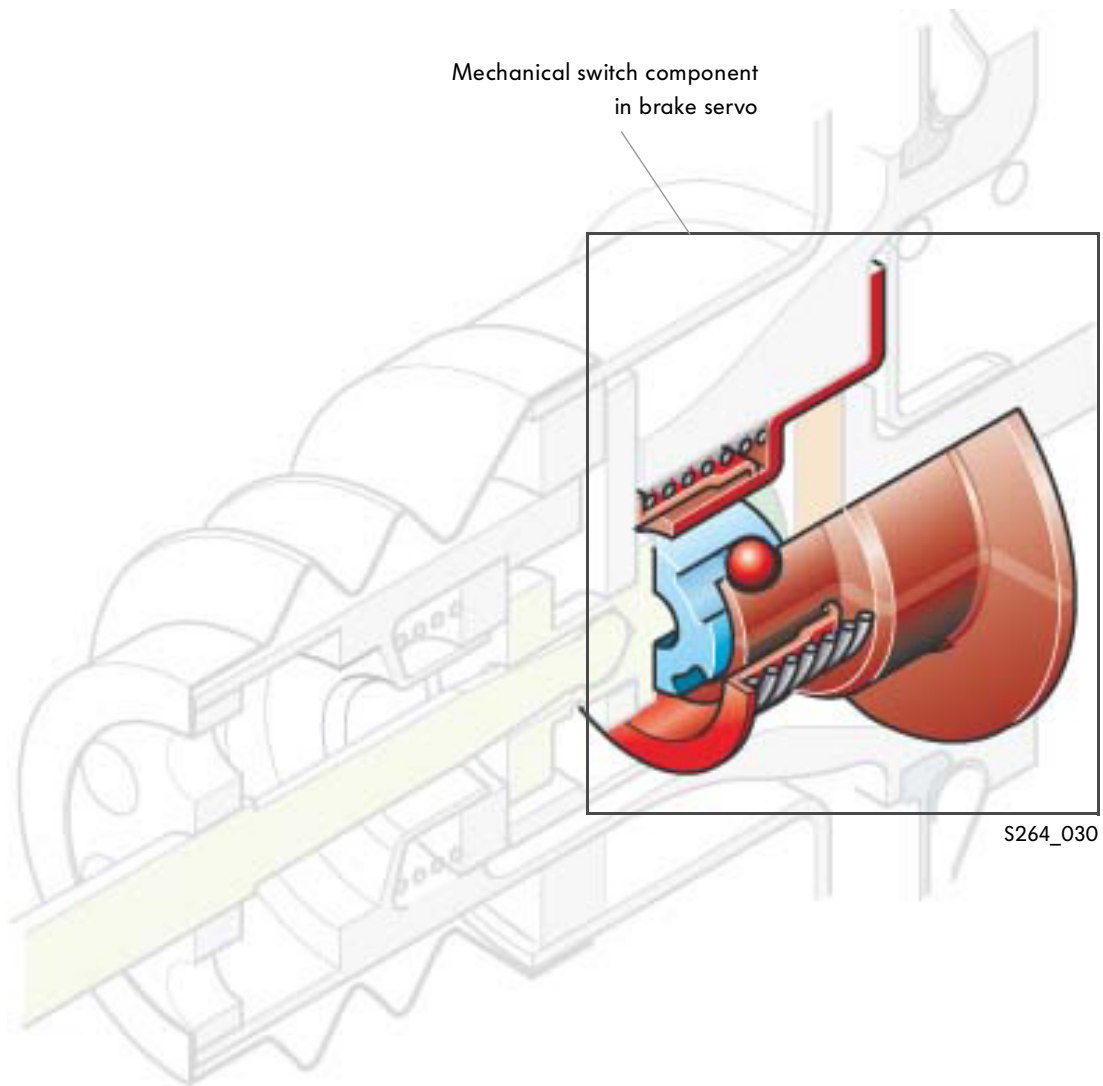

S264_030

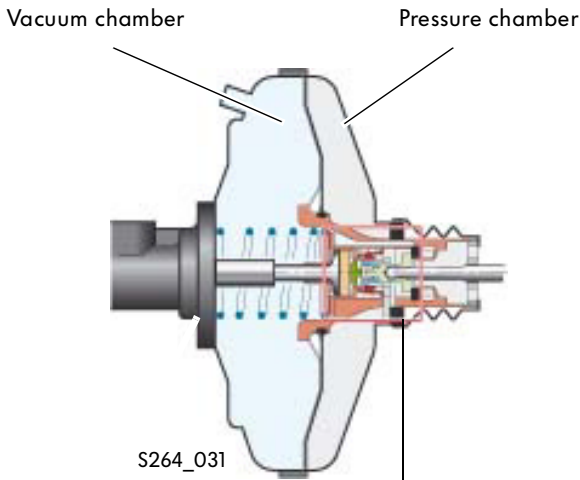

Switch component
in control housing

The brake servo has a pressure and a vacuum chamber. When the brakes are not applied, vacuum is created by the intake manifold in both chambers. The brake force is amplified when, during brake application, the pressure chamber is pressurised with atmospheric pressure. This creates a pressure differential between pressure and vacuum chambers, so that the external air pressure supports the braking motion.

The mechanical switch component consists of a locking sleeve with spring, a valve piston and a ball cage with balls and ball sleeve.

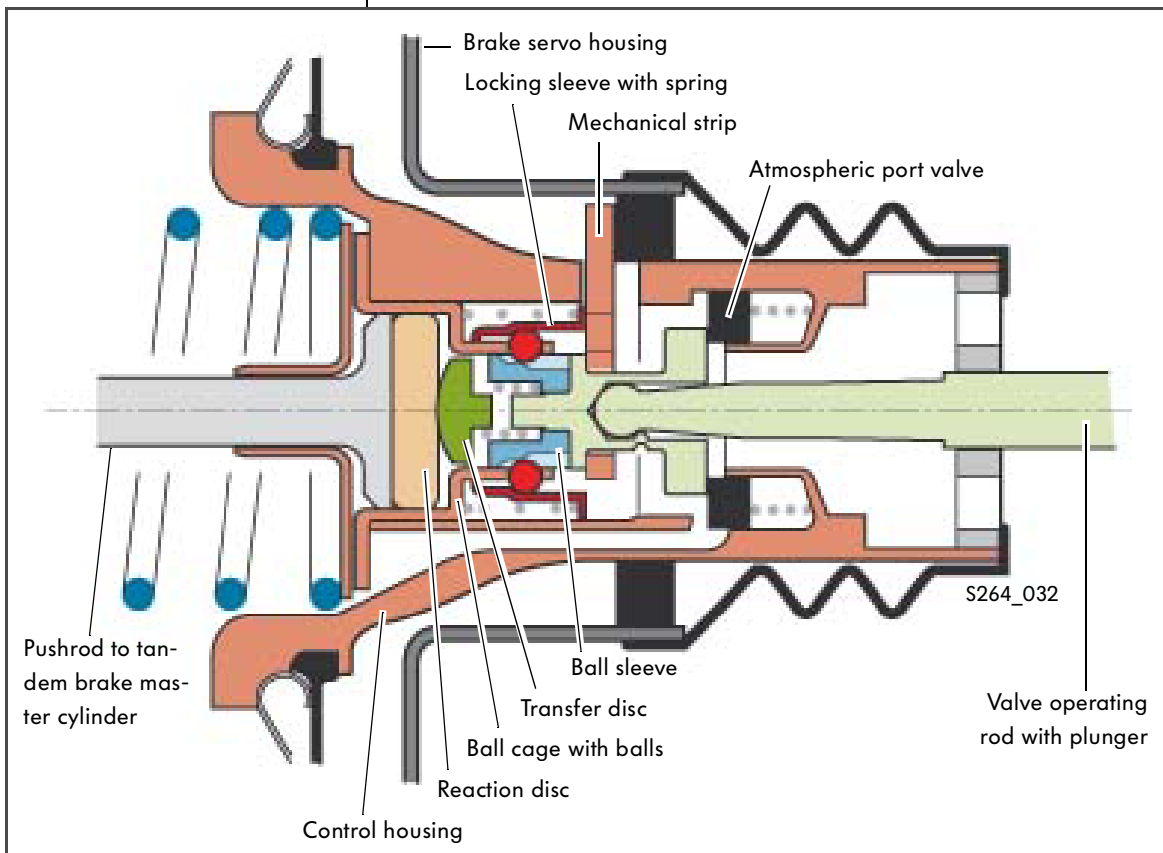

The mechanical brake assist system

... and Function

As pressure develops in the brake system, the driver feels a counter-pressure in the brake pedal. The principle of the mechanical brake assist system is to divert this force to the control housing, relieving the driver physically. The locking mechanism holds the atmospheric port valve open and provides air to the pressure chamber.



Path of force without brake assist system

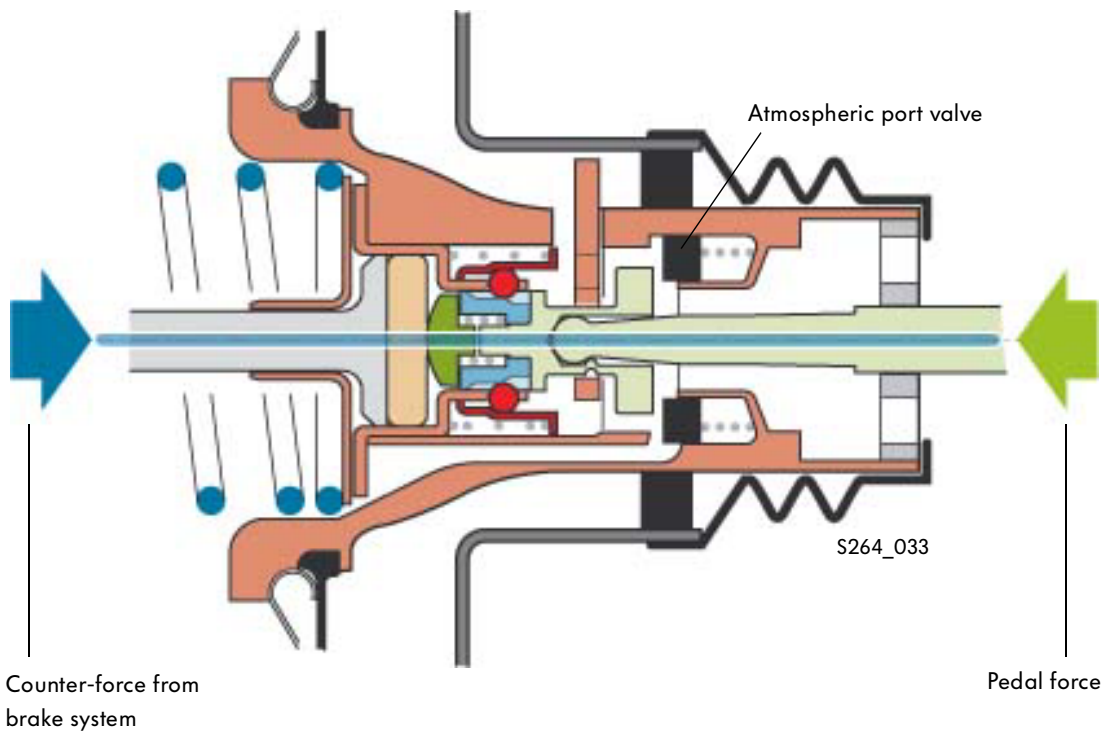

Path of force with brake assist system

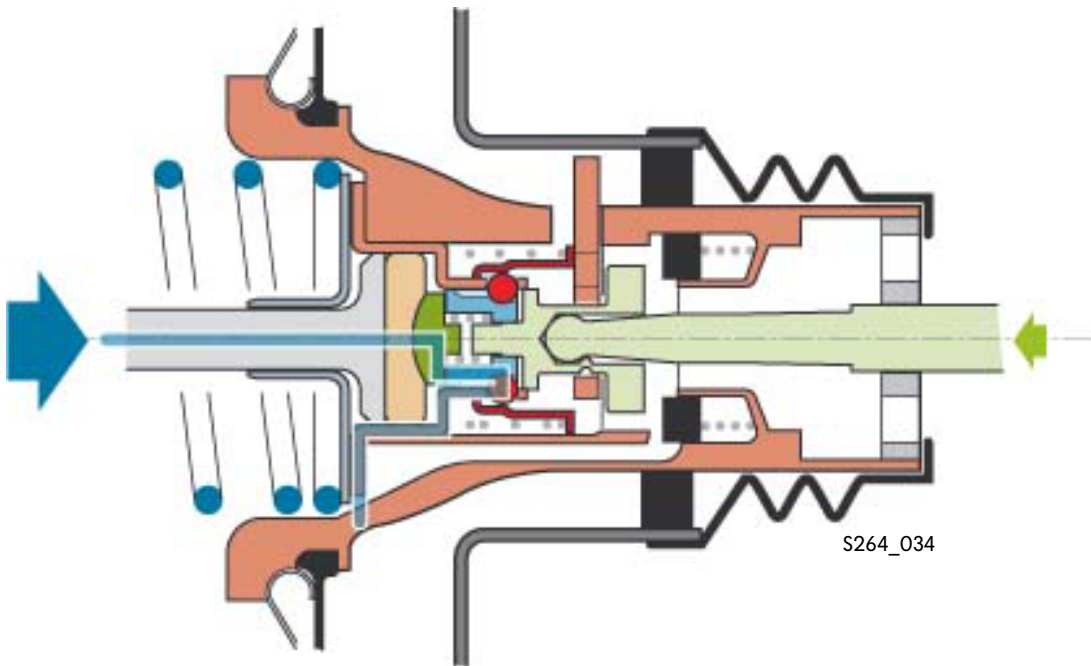

S264_034



When the brake pedal is pressed with a certain force and a certain velocity, the switch component locks and the brake assist system intervenes.

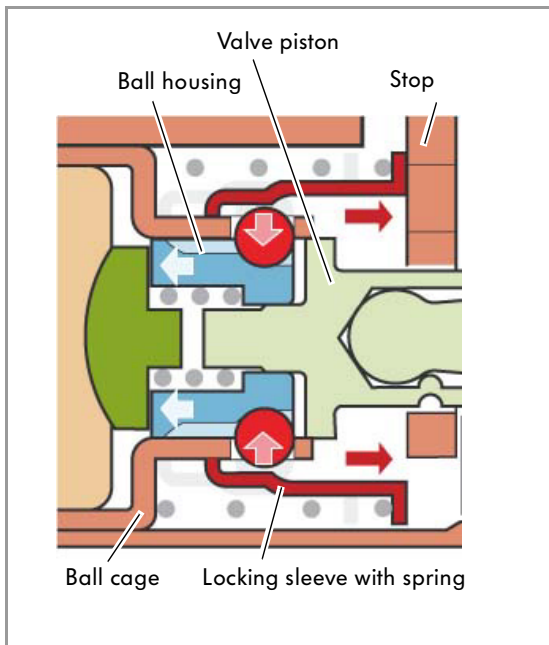



In this case, the valve piston moves and the balls are moved inward in the ball cage. Consequently the locking sleeve can move to its stop. The switch component is locked.

Because the mechanical events are difficult to present in a detailed diagram, the individual steps will be explained in strongly simplified drawings.

Switch component in emergency braking operation S264_038

The mechanical brake assist system

Assembly group	Parts	Colour
a	Valve operating rod, valve piston, ball housing, transfer disc	
b	Locking sleeve, mechanical stop	
c	Ball cage, balls, control housing	

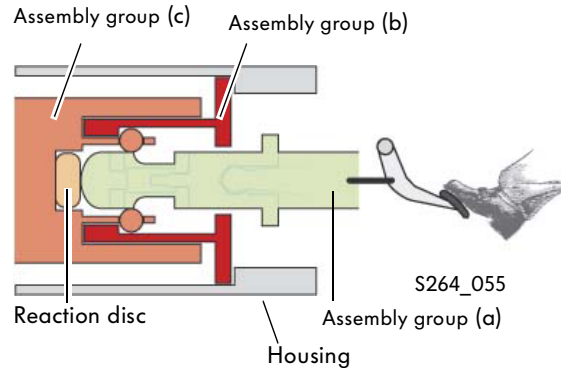

If the brake is applied too slowly, the brake assist function is not triggered. That means that the driver feels the full counter-pressure from the brake system through the brake pedal as counter-force which he must overcome in order to brake more heavily.

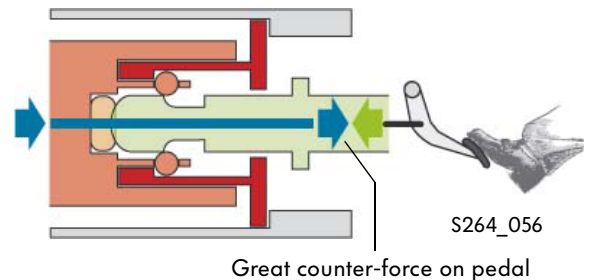

If the brake pedal is pressed very fast, the brake assist function is triggered. The major portion of the counter-force is diverted through the locking of the assembly groups to the housing. The driver has to overcome only a very small force to brake more heavily.

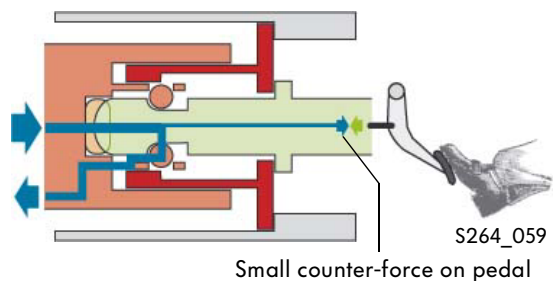

Brake assist system intervention

A relation of two values triggers the mechanical brake assist system. One is the velocity with which the brake pedal is pressed and the other is the force of the brake pedal.

The trigger threshold is presented in the graph. In the green area above the trigger threshold, the brake assist system is active.



Example:

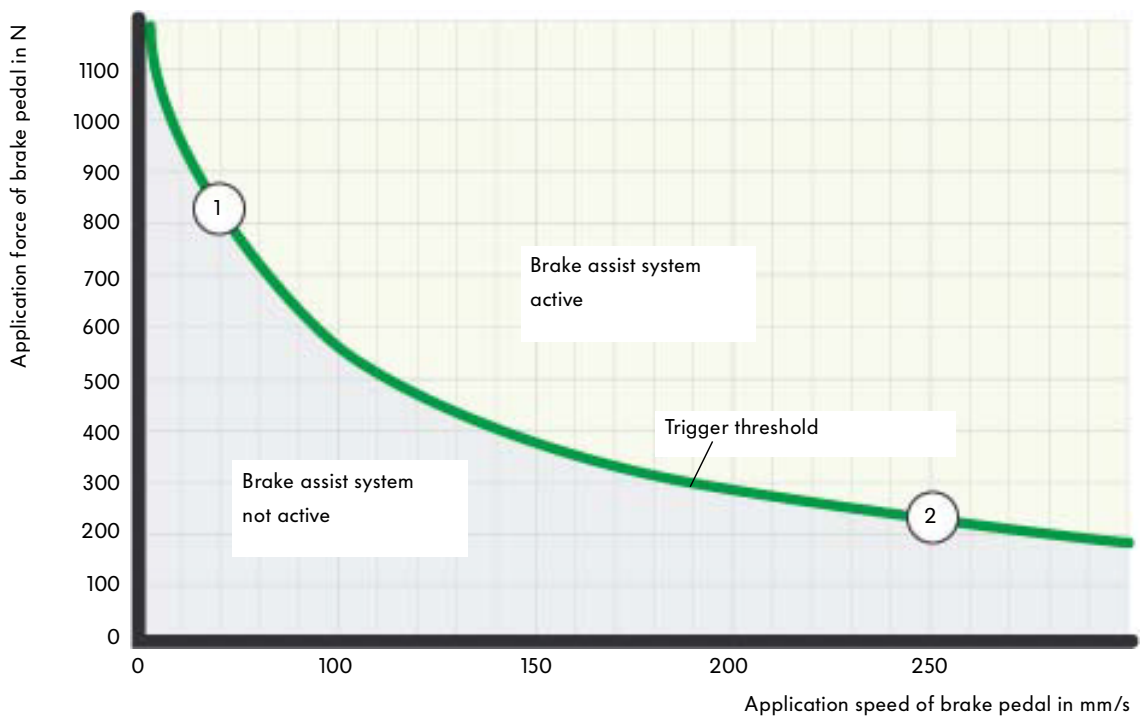

S264_082

- 1 Low application speed at high application force
- 2 High application speed at low application force

The mechanical brake assist system

In Detail

The following, strongly simplified drawings illustrate the movements of the individual parts in relation to each other.

If the trigger threshold is exceeded, the green assembly group presses hard into the reaction disc. Due to its inertia, the light red assembly group cannot respond so quickly to the fast initial movement.

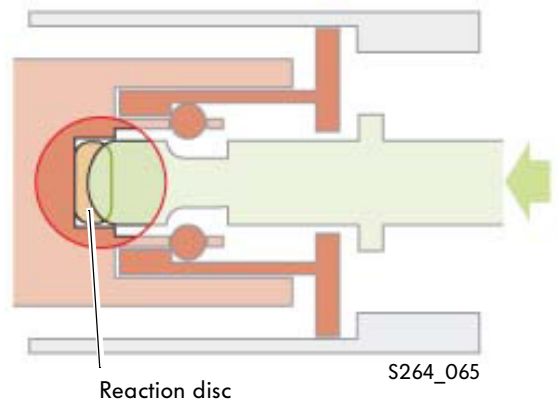

The movement of the green assembly group in relation to the light red group, enables the balls to roll into the groove in the green group.

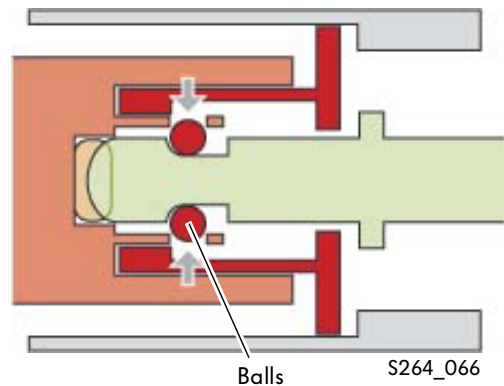

Only now can the locking sleeve (dark red) can slide over the balls, locking the switch component. The balls cannot return to their initial position due to the new position of the locking sleeve.

In this position, the counter-forces are diverted, as previously explained, from the brake system onto the housing.

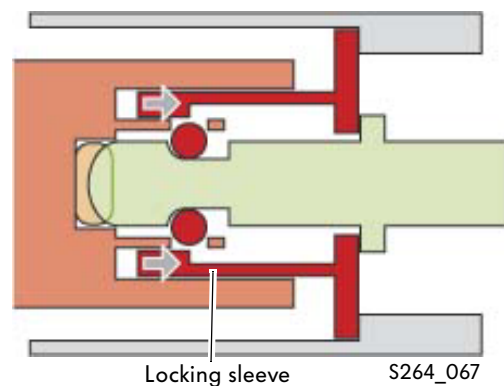

Concluding the brake assist function

If the driver takes his foot from the brake pedal, both red and the green assemblies move back together until the stop rests against the housing.

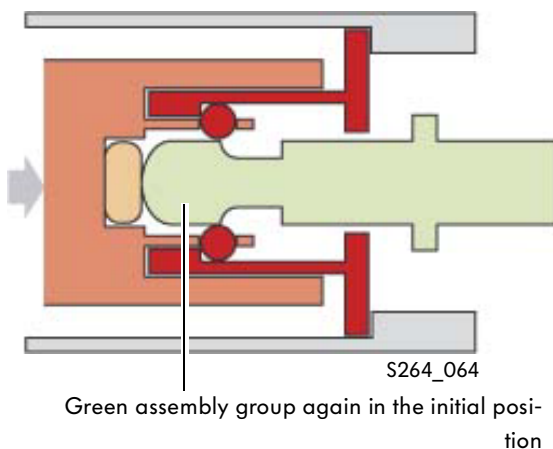
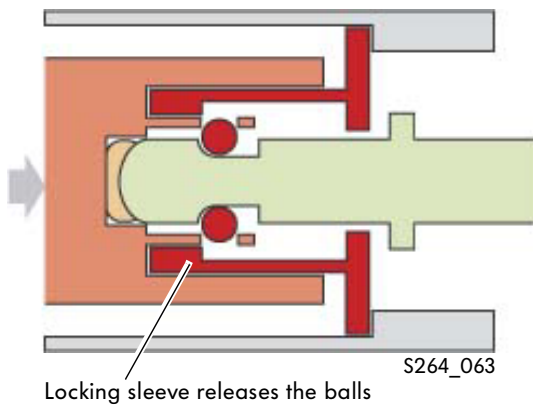
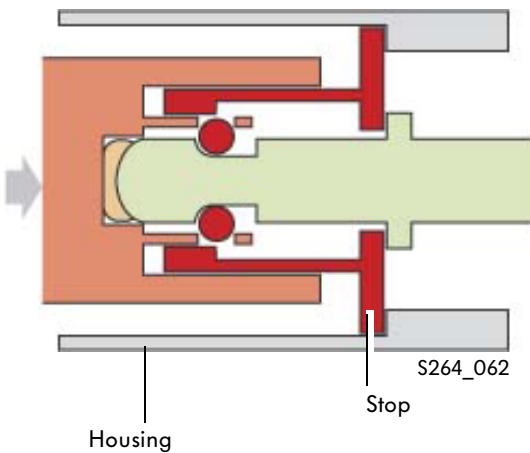

Because the entire mechanism moves further back within the brake servo, the light red part now moves in relation to the dark red part. Consequently, the locking sleeve releases the balls.

In the last phase of the movement, the balls are pressed back into their initial position by the green assembly group.

The emergency brake assist function is switched off.



Service

Testing function

The brake pedal must be pressed with the engine running and the vehicle stationary so that the maximum vacuum boost is assured.

The mechanical brake assist system will be activated when the brake pedal is pressed to stop above the trigger threshold. A click in the brake servo can be heard when the brake assist system is triggered. The brake pedal can now be partially released and pressed with a small force.

When the brake pedal is released completely, the brake assist system must release (no hydraulic pressure in the brake system).

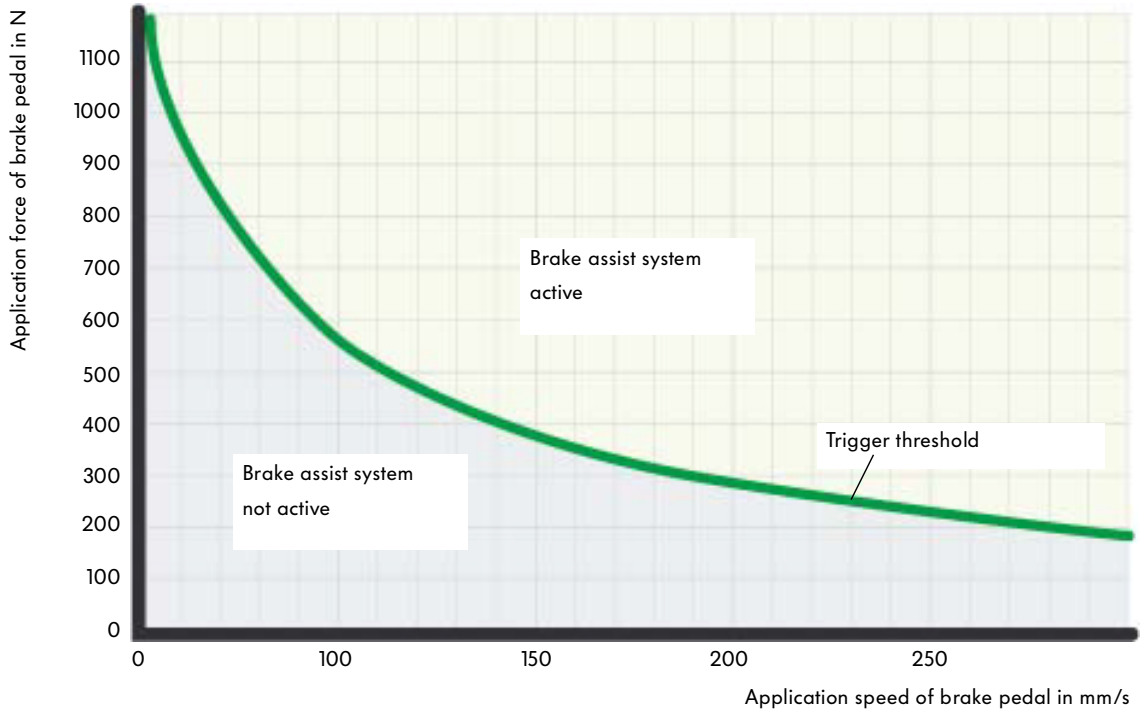

S264_083

Test your knowledge

1. What is the function of the brake assist system?

- a It prevents the wheels from locking during emergency braking.
- b It supports the driver when braking in emergency situations.
- c It indicates to the driver how hard he must brake.
- d It attains the greatest possible braking effect while maintaining steering ability.

2. In which vehicles is the hydraulic brake assist system currently installed?

- a Golf
- b Polo 2002
- c Passat W8
- d Lupo 3L

3. The signals of which sensors are used for evaluating the trigger conditions?

- a Brake pressure sender
- b Engine speed sender
- c Speed sensors on wheels
- d ABS pressure sender
- e Brake light switch



Test your knowledge

4. Identify the components in the drawing.

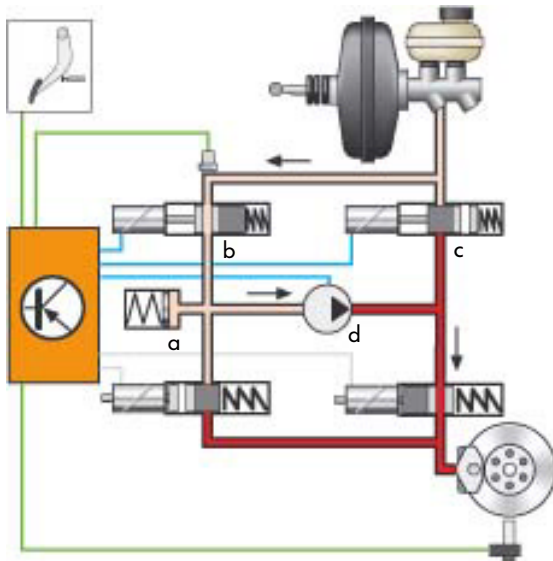

a = _____

b = _____

c = _____

d = _____

5. What is the effect of the mechanical brake assist system based on?

- a The intake manifold vacuum works against the brake force so that the driver does not feel any counter-force in the brake pedal.
- b The counter-force from the pressure build-up in the brake system is diverted to the control housing.

6. Which conditions must be fulfilled to activate the mechanical brake assist system?

- a The application force must be sufficiently great when the application speed is low.
- b The application speed must be sufficiently great when the application force is small.
- c The activation condition depends entirely on the distance the pedal moves.

Answers:

1. b, d
2. b, c
3. a, c, e
- 4.
- a = Accumulator
- b = ESP (brake pressure) switch valve N225
- c = ESP high-pressure valve N227
- d = Return flow pump
5. b
6. a, b



For internal use only © VOLKSWAGEN AG, Wolfsburg

All rights reserved. Technical specifications subject to change without notice.

140.2810.83.20 Technical status 09/01

 This paper was produced from
non-chlorine-bleached pulp.