

Service



Self-Study Programme 223

The 1.2l and 1.4l TDI engines

With Pump Injection System

Design and Function

T D I



T D I

Following the successful launch of 1.9l 4-cylinder TDI engines with unit injector system in the Golf and Passat, the trend towards economical, low-emission and simultaneously powerful direct-injection turbodiesel engines is continued in the Polo and Lupo by the 3-cylinder TDI engine.

By eliminating a single cylinder, the engines are now lighter, have fewer moving masses and produce less friction than a 4-cylinder engine. Despite their lower displacement, they have a high performance potential for this vehicle class.

Particularly in the 1.2l TDI engine developed specially for the Lupo 3L, numerous new technologies and production methods have been employed in order to achieve the development goal of reducing fuel consumption to 3 litres per 100 km. This consumption figure was made possible by saving weight, reducing friction and improving the combustion process.

In this Self-Study Programme, you have the opportunity to familiarise yourself with this new engine generation, which is exemplified by the 1.2l and 1.4l TDI engines.

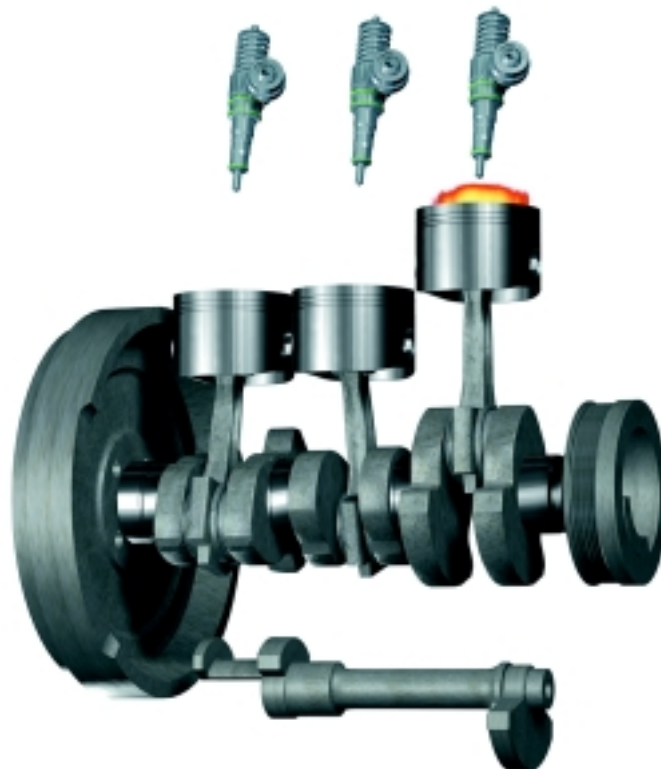

223_213

New

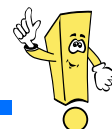

Important Note



The Self-Study Programme describes the design and the function of new developments! The contents are not updated!

Please always refer to the relevant Service Literature for all inspection, adjustment and repair instructions. Literature.

Contents



Introduction	4
Engine mechanicals	8
Unit injector system	27
Fuel supply	38
Exhaust system	43
Engine management	46
Function diagram	70
Starter motor	72
Engine management (special features of the Lupo 3L)	76
Service	79
Test your knowledge	85

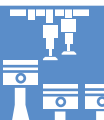

Introduction

Installation variants

The **1.2l TDI engine** is combined with the DS 085 electronic manual gearbox and is fitted exclusively in the Lupo 3L.

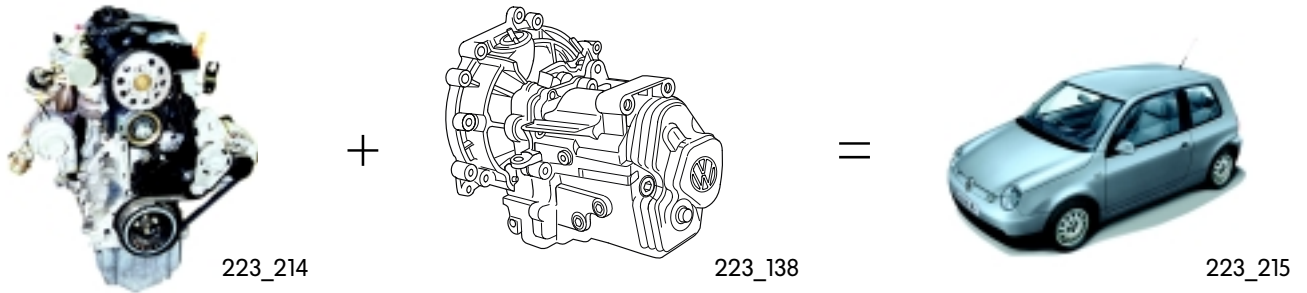

The **1.4l TDI engine** is combined with 5-speed manual gearbox 02J and is fitted in the Lupo, Polo and Audi A2.

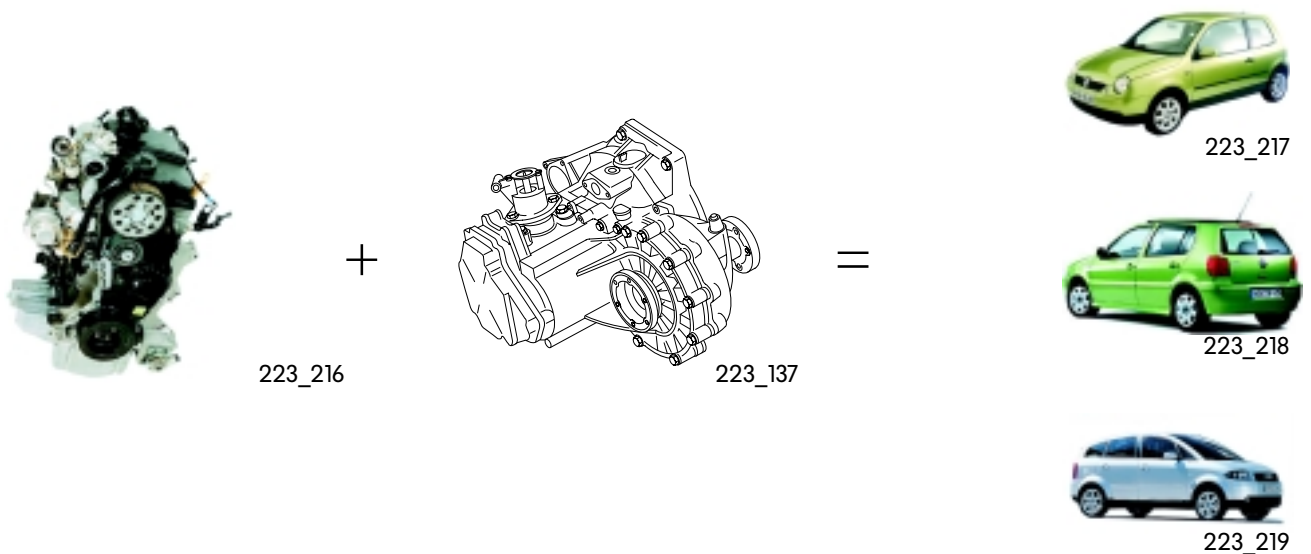

You will find detailed information regarding Lupo 3L and Audi A2 in the following Self-Study Programmes:

- No. 216 „Lupo 3L Body“
- No. 218 „Lupo 3L TDI“
- No. 221 „The DS 085 Electronic Manual Gearbox“
- No. 239 „Audi A2 - Body“
- No. 240 „Audi A2 - Engineering“
- No. 247 „Audi A2 - Engine and Gearbox“

Designations and levels of development of the engines

Both the 1.2l engine and the 1.4l TDI engine were developed on the basis of the 1.9l TDI engine without intermediate shaft and with unit injector system. They belong to the EA 188 engine series (EA=development order). As this designation often appears in specialist publications, we shall now briefly explain the various diesel engine series of Volkswagen.

The four-cylinder diesel engines are subdivided into two series: the EA 086 series of swirl chamber engines and the EA 180 series of direct injection engine engines. A key feature of these engine series is the intermediate shaft which drives the oil pump and the vacuum pump. The EA 180 engines were revised with the introduction of the new A-platform class in 1996. This gave rise to the EA 188 engine series.

This new engine series does not have an intermediate shaft. The oil pump is driven by the crankshaft by means of a chain. The vacuum pump is mounted on the cylinder head and is driven by the camshaft. Further features of the new engine series are the upright oil filter housing, the coolant pump integrated in the cylinder block and the pendulum support.

Further engine series are the 5-cylinder inline engine series EA 381 and the V6 TDI engine series EA 330 launched in 1997.

Engine series EA 180

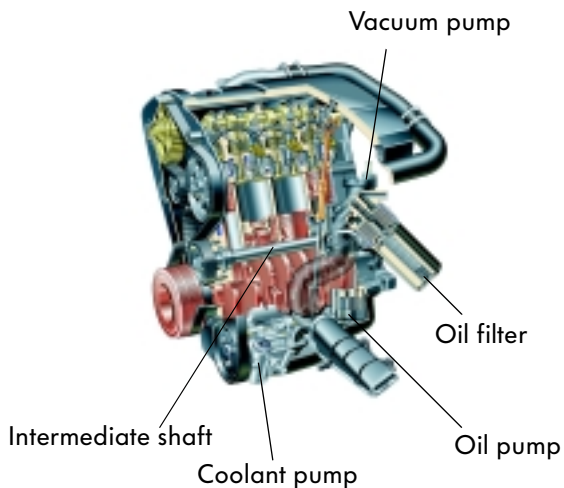

223_220

Engine series EA 188

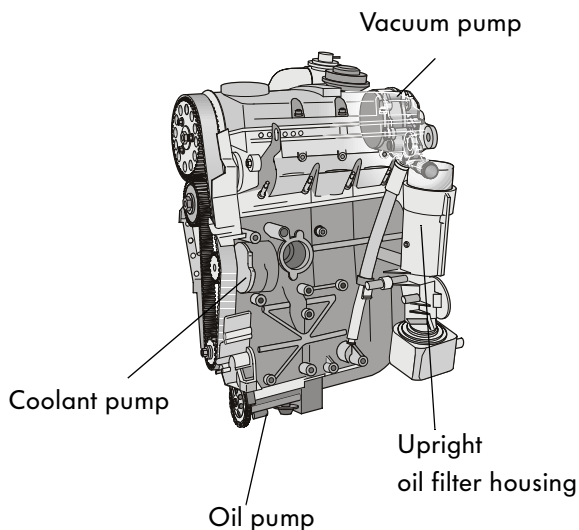

223_164



Introduction

Specifications



	 223_214	 223_216
Engine	1.2l TDI engine	1.4l TDI engine
Engine code	ANY	AMF
Type	3-cylinder inline engine	3-cylinder inline engine
Displacement	1191 cm ³	1422 cm ³
Bore / stroke	76.5 mm / 86.7 mm	79.5 mm / 95.5 mm
Compression ratio	19.5: 1	19.5: 1
Firing order	1 - 2 - 3	1 - 2 - 3
Engine management	BOSCH EDC 15 P	BOSCH EDC 15 P
Fuel	Diesel min. 49 CN or biodiesel (RME)	Diesel min. 49 CN or biodiesel (RME)
Exhaust gas aftertreatment	Exhaust gas recirculation and oxidation catalytic converter	Exhaust gas recirculation and oxidation catalytic converter
Exhaust emission standard	Conforms to exhaust emission level D4	Conforms to exhaust emission level D3

Power output and torque



Performance diagram

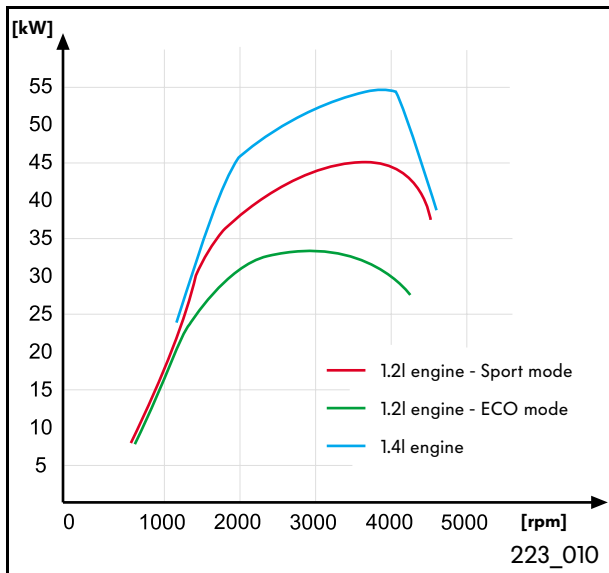

The maximum power output of the 1.4l TDI engine is 55 kW at 4000 rpm.

The 1.2l TDI engine has two different performance levels.

To achieve consumption figures of 3 litres per 100 km, the Lupo 3L has an Economy mode in which engine performance is reduced by the engine management system.

For a more sporty driving style, the engine can be operated in the performance-oriented Sport mode.

As the reference performance curve shows, the maximum output of the 1.2l TDI engine is 45 kW at 4000 rpm. In Economy mode, maximum power output is 33 kW at 3000 rpm.

Torque diagram

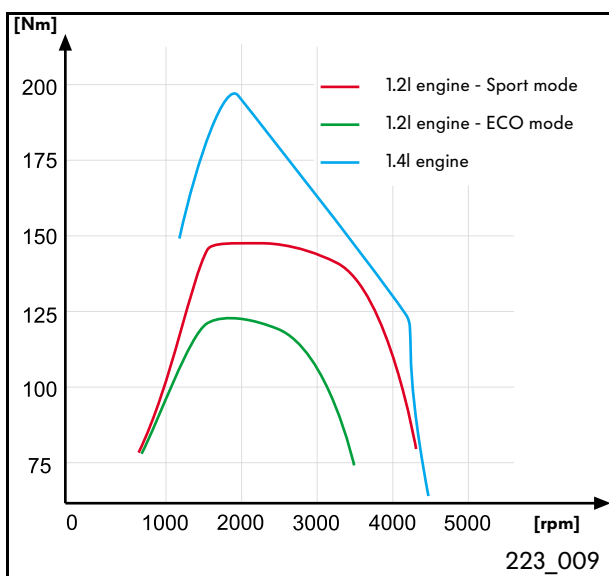

The 1.4l TDI engine develops 195 Nm of torque at 2200 rpm, hence the engine's high tractive power and elasticity in the lower and medium speed ranges.

When the 1.2l TDI engine is in Sport mode, the maximum torque of 140 Nm is available between 1800 rpm and 2400 rpm.

In Economy mode, maximum torque is 120 Nm between 1600 and 2400 rpm.

As a result, high torque is available in the speed range which is predominantly used.

Engine mechanicals

The cylinder block

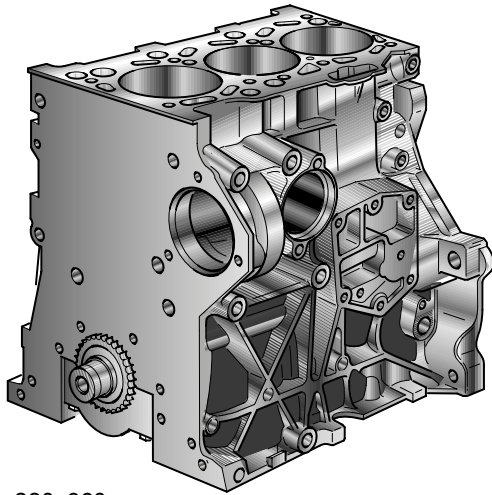

223_093

1.4l TDI engine

The 1.4l TDI engine has a gray cast iron cylinder block.

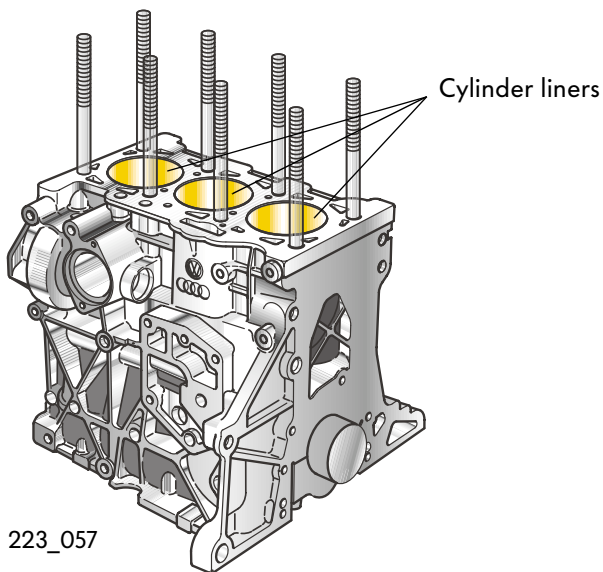

223_057

1.2l TDI engine

The cylinder block of the 1.2l TDI engine is manufactured from an aluminium alloy to save weight and minimise the fuel consumption of the Lupo 3L.

The gray cast iron cylinder liners of the engine are press-fitted and cannot be replaced.



The crankshaft bearing covers may not be detached and the crankshaft may not be removed. Undoing the bearing cover bolts causes the aluminium bearing seats to lose shape due to relaxation of their inner microstructure. If the bearing cover bolts are undone, then the cylinder block has to be replaced complete with the crankshaft.

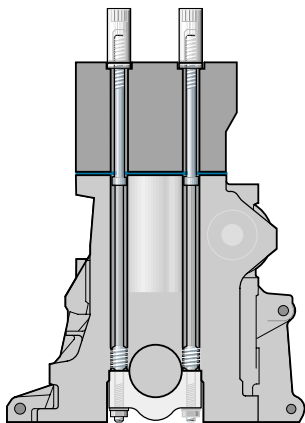

223_059

The tension bolt

Aluminium is not as strong as gray cast iron. If the cylinder head in the cylinder block has a conventional threaded connection, there is a danger of the threaded connection coming undone due to the high combustion pressures which develop inside diesel engines.

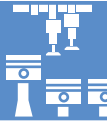

For this reason, the cylinder head and the cylinder block are bolted together by tension bolts. The tension bolts permit a continuous flow of force from the cylinder head to the bearing cover, securely holding the engine together even under heavy load. This makes for a secure threaded connection and reduces the strain on the cylinder block.

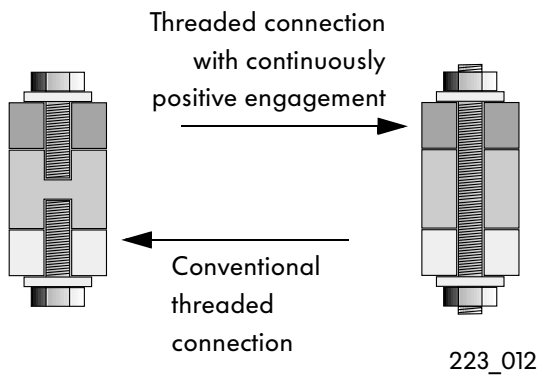

223_012

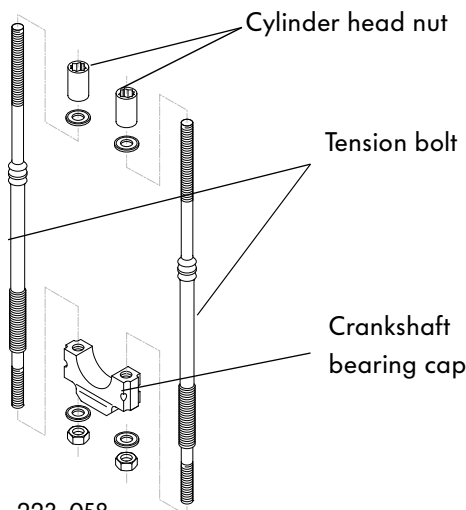

223_058

Steel pins serve as tension bolts: they bolt the aluminium cylinder block to the cylinder head and the crankshaft bearing cap of the 1.2l TDI engine.

They are securely glued into the cylinder block with „Loctide“ locking fluid and cannot be replaced.



During installation of the cylinder head, tightening of the cylinder head nuts puts a high torsional strain on the tension bolts. To reduce the strain, the cylinder head nuts have to be slackened. Please observe the instructions in the Workshop Manual!

Engine mechanicals

The balancing shaft

A balancing shaft is located in the engine's crankshaft drive. Its task is to reduce vibration and thereby ensure that the engine runs smoothly.

The balancing shaft is attached to a ladder-type frame and is driven by the crankshaft by means of a chain. It rotates at engine speed in the opposite direction to the engine.

The upwards and downwards movements of the piston and conrod and the turning motion of the crankshaft produce forces which induce vibrations. These vibrations are transmitted through the assembly mounting to the vehicle body. To reduce vibration, the balancing shaft counteracts the forces of the piston, conrod and crankshaft.

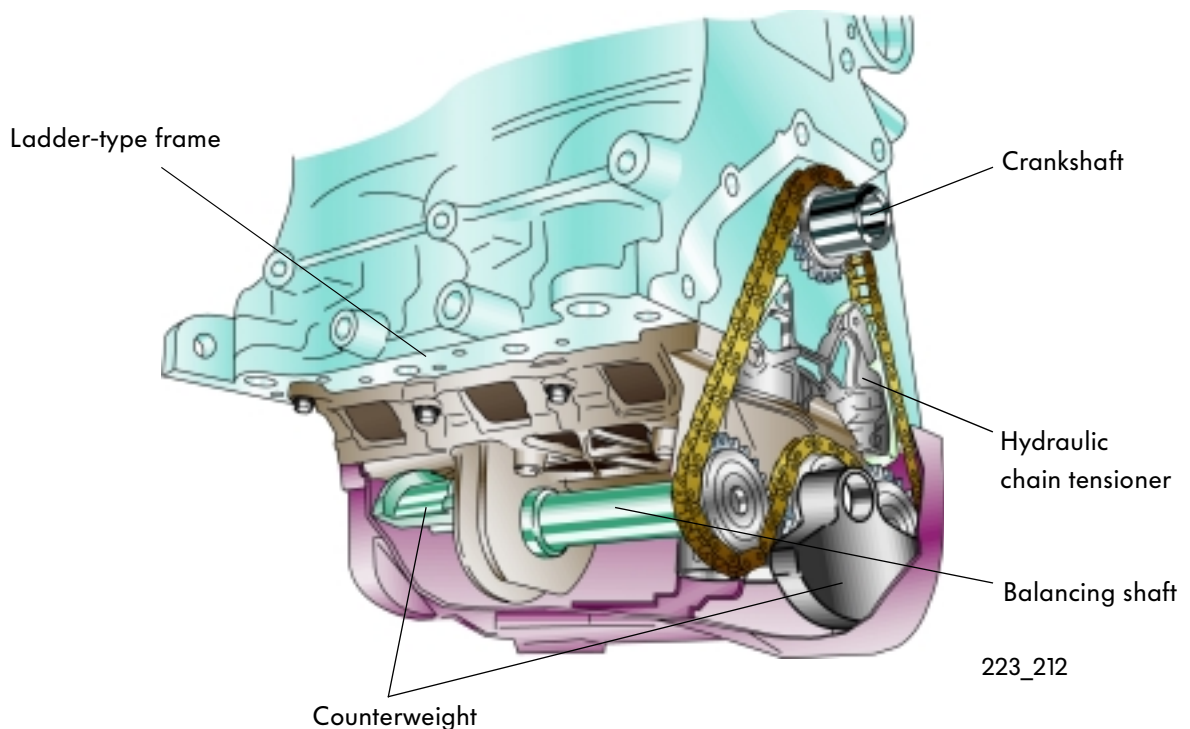

To be able to better understand the operating principle of the balancing shaft, several basic physical terms are briefly explained on the following pages.

What is force?

The concept of "force" is derived from the tensing of muscles as experienced when lifting or pulling an object. When a force acts upon a solid object, it can cause the object to become deformed, accelerate or produce a counterforce of equal magnitude.

Other permutations are also possible.

Example:

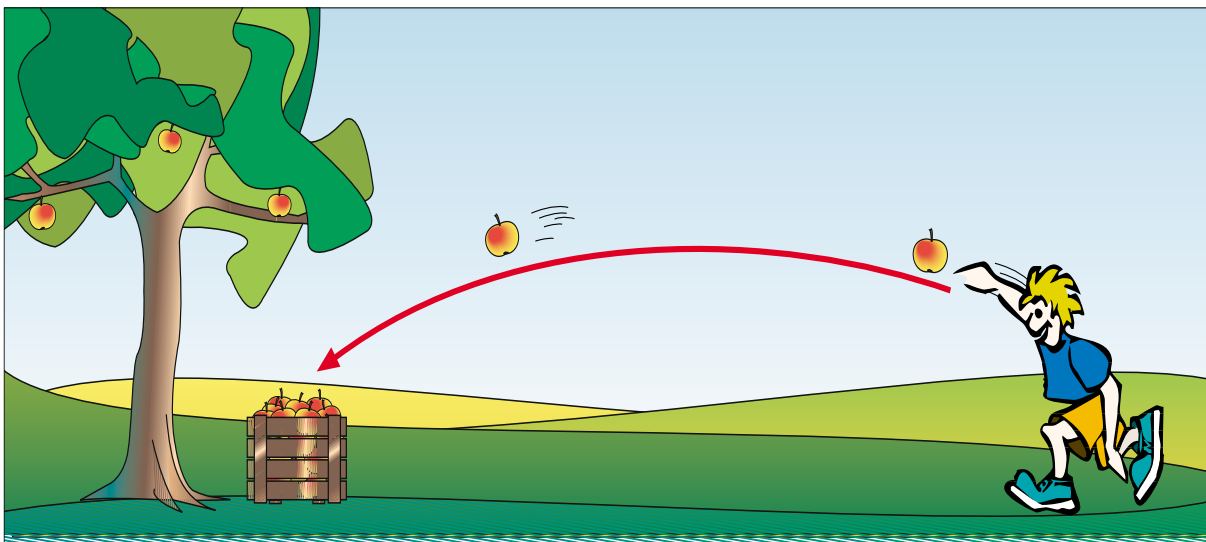

223_198

When an apple is thrown, it is accelerated by the effect of muscular power. The magnitude of the force required to throw the apple is dependent on the apple's mass (weight) and acceleration.

In a drawing, the magnitude of a force, its direction of action and the point of application are represented by an arrow.

$$\text{Force} = \text{mass} \times \text{acceleration}$$

Engine mechanicals

Force due to weight.

Another form of force is force due to weight.

Due to gravitational acceleration, each body moves towards the earth's surface and produces a force due to weight. The force due to weight is dependent on the mass of a body and the gravitational acceleration, and is generally referred to as the „force of attraction“. The greater the mass of the object, the greater the force due to weight.

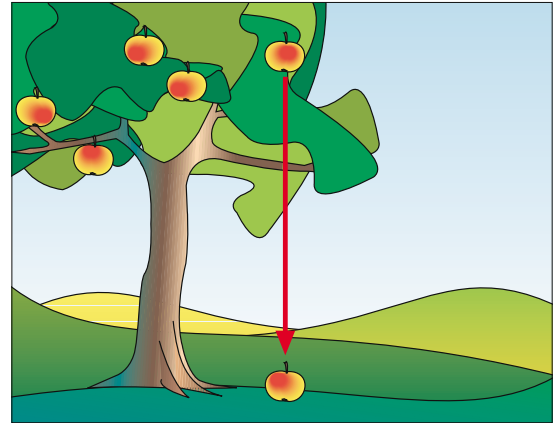

223_086

$$\text{Force due to weight} = \text{mass} \times \text{gravitational acceleration}$$

What is torque?

If a force acting vertically on an object induces a rotational motion via a lever, this is referred to as 'torque'. Since neither the force nor the lever arm alone determine the direction of rotation, the product of both is referred to as torque. Torque increases as a function of increasing force or lever arm length.

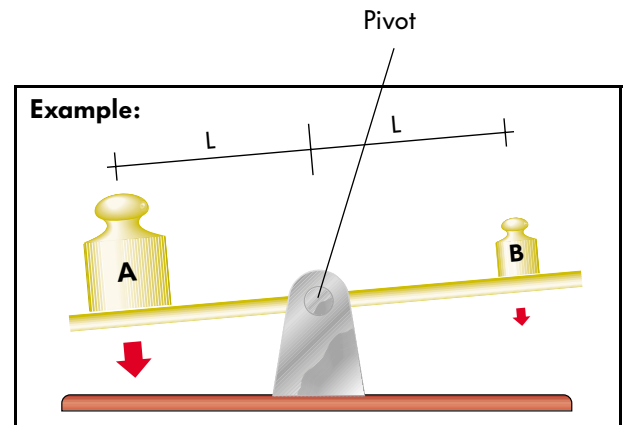

(L= length)

223_195

$$\text{Torque} = \text{force} \times \text{lever arm}$$

Example:

Two weights are located on a balance. Weight A is twice as heavy as weight B. On account of its higher mass, it produces greater torque as than weight B and lifts weight B because of this.

How do torques cancel each other out?

Moments cancel each other out when the force counteracts a force of equal magnitude at equal distances from the pivot.

Example 1:

- Three weights are located on the balance. Weight A is on the left-hand side and weights B1 and B2 are on the right-hand side. As weights B1 + B2 are equally as heavy as weight A, the force and counterforce cancel each other out, i.e. a force equilibrium exists.

Example 1:

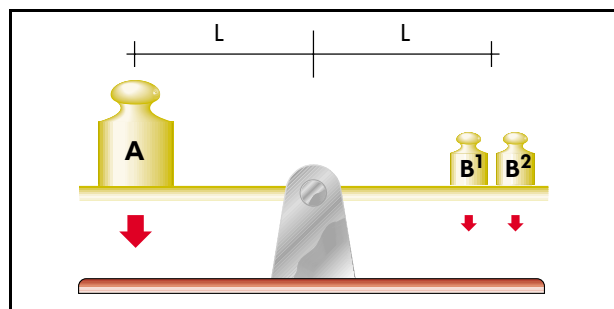

223_197

or:

Moments cancel each other out when a counterforce of half the magnitude counteracts the force at twice the distance from the pivot.

Example 2:

- Two weights are located on the balance. Weight A is on the left-hand side and weight B is on the right-hand side. Weight B is located twice the distance away from the pivot. As a result, the torques on both pages are equalised and a force equilibrium exists.

Example 2:

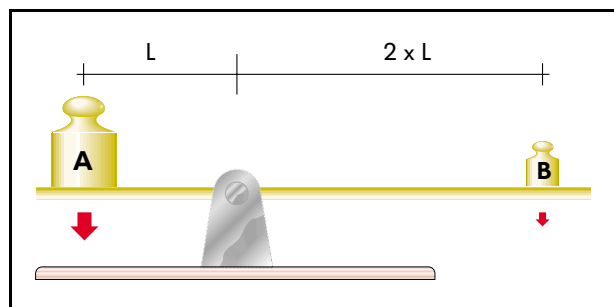

223_196

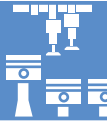

Engine mechanicals

Inertia forces

Inertia forces occur in the engine's crankshaft drive. There are two types of inertia force: rotating inertial forces and oscillating inertial forces.

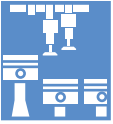

Rotating inertia forces are produced by the turning motion of the crankshaft (action of centrifugal force).

rotation = orbital motion around own axis

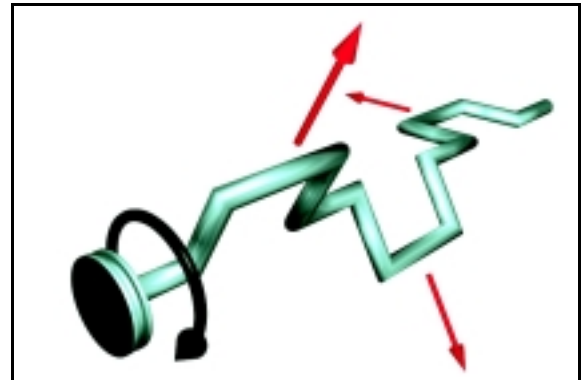

223_222

Oscillating inertia forces are produced by the upwards and downwards movements of pistons and conrods.

oscillation = back and forward swinging motion

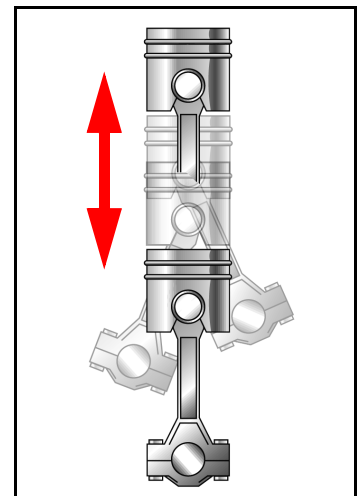

223_257

How do inertia forces affect the 3-cylinder TDI engine?

When one observes the crankshaft of the 3-cylinder TDI engine from the side, the crank throws are uniformly arranged in relation to the crankshaft's pivot. The throws are spaced 120° apart. As a result, the inertia forces cancel each other out.

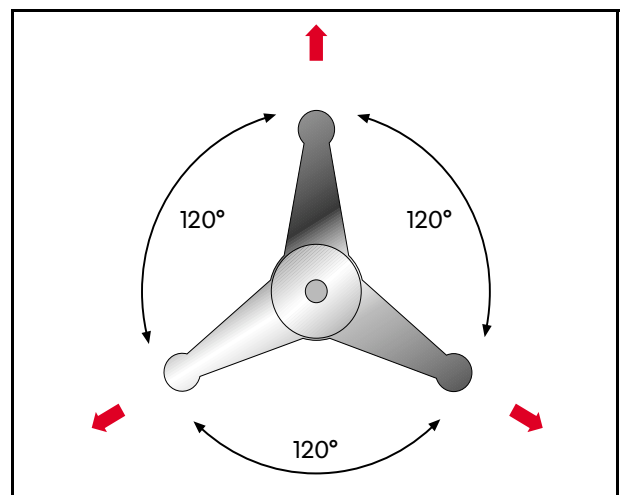

223_182

Mass moments of inertia

Mass moments of inertia occur in the crankshaft drive of the 3-cylinder TDI engine since the inertia forces act upon the centre point of the crankshaft via different lever arms.

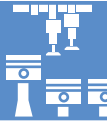

4-cylinder engine

The crankshaft of the 4-cylinder inline engine appears symmetrical from the long side. The crankshaft throws have the same distance in relation to the centre point of the crankshaft. As a result, the mass moments of inertia cancel each other out.

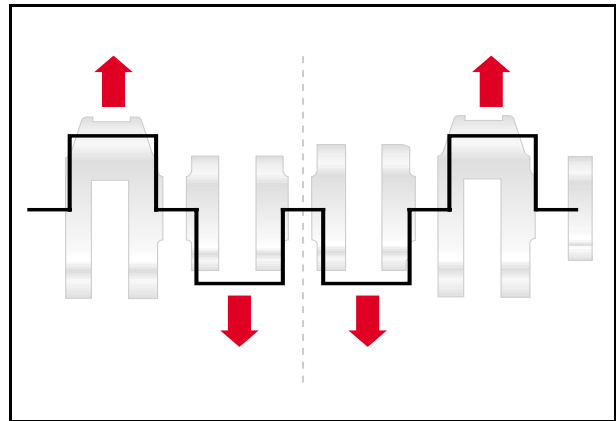

223_177

3-cylinder engine

The crankshaft of the 3-cylinder inline engine is not symmetrical, because the throws are different distances away from the centre point of the crankshaft. As a result, the mass moments of inertia do not cancel each other out.

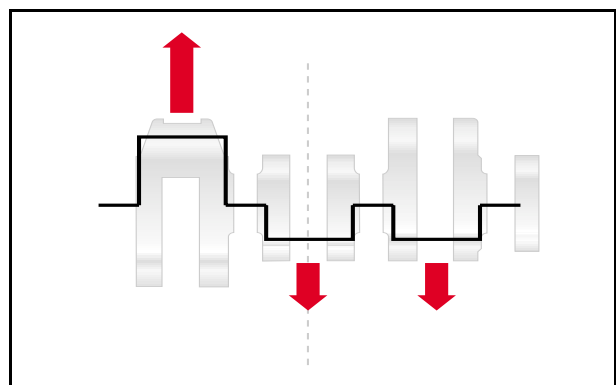

223_176

Engine mechanicals

How do the mass moments of inertia affect the 3-cylinder TDI engine?

The centrifugal action of the **rotating mass moments of inertia** induces a circular wobbling movement of the crankshaft about the longitudinal axis.

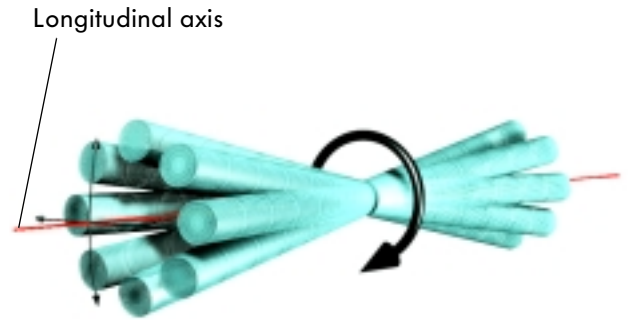

223_223

The rotating mass moments of inertia are compensated by counterweights on the 1st and 3rd throws of the crankshaft web. As there is not enough space for a suitably large counterweight

in the crankcase of the 3-cylinder TDI engine, additional weights are attached to the vibration absorber and the flywheel.

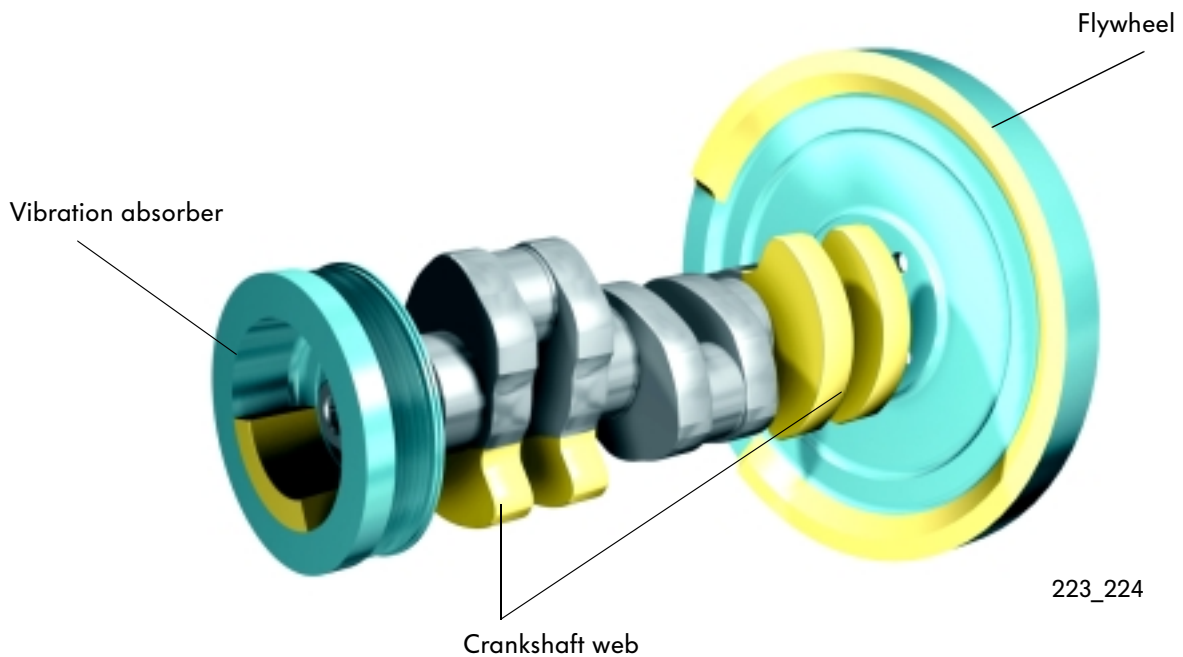

223_224

The **oscillating mass moments of inertia** induce a seesaw movement of the crankshaft about the transverse axis.

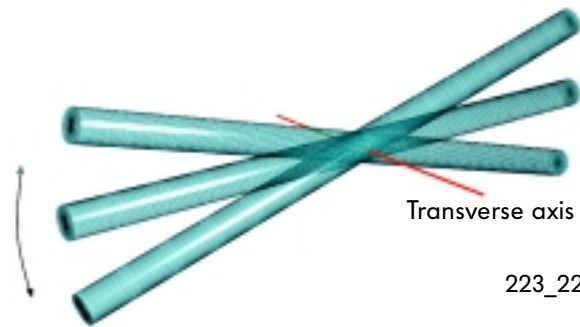

To compensate for this seesaw movement, weights on the balancing shaft and the crankshaft webs produce forces which counteract the oscillating mass moments of inertia of the crankshaft. They form two couples which counterrotate at the same speed. The centrifugal action produces two rotating moments. As soon as the weights stand perpendicular to the cylinder axis, the direction of action of two forces is identical. The torques add up and, as a result, are of equal magnitude to the oscillating moments of the piston and conrod.

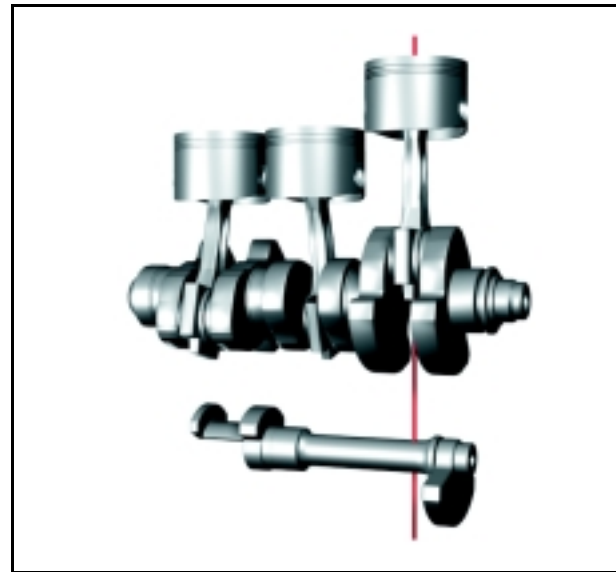

In the direction of the transverse axis, the rotating moments cancel each other out because the rotating forces act in opposite directions due to the counteropposed turning motion of the crankshaft and balancing shaft.

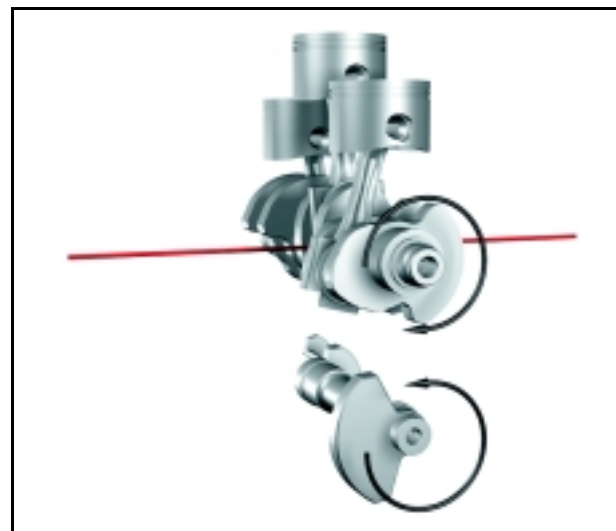

Engine mechanicals

Repair notes:

For effective balancing of masses, the crankshaft and balancing shaft must converge in the correct position. For this purpose, the marks on the crankshaft gear and balancing shaft gear must be aligned with the two coloured links on the drive chain when installing the drive chain.

To maintain an even load on the chain, the reduction ratio of the gears is configured in such a way that the marked chain links do not coincide with the marks until the engine has completed several revolutions.

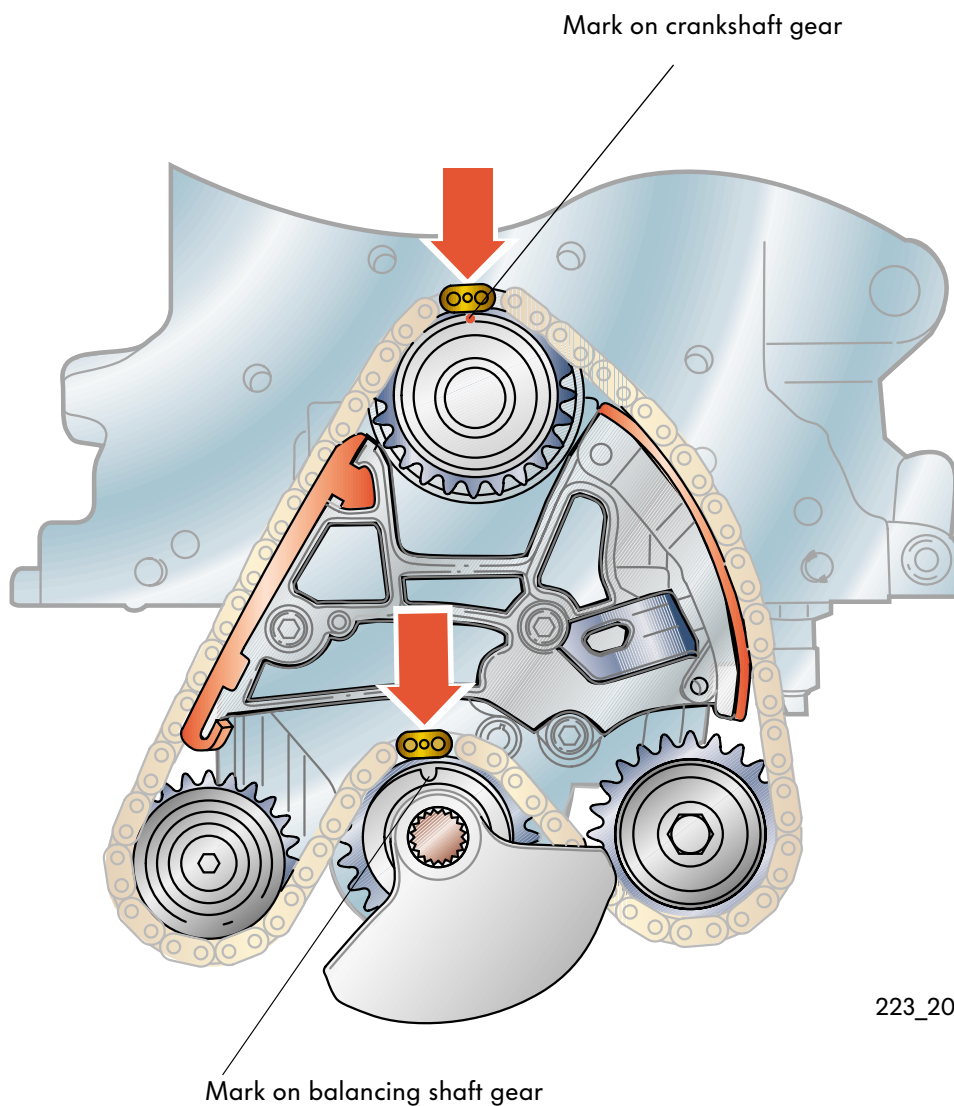

223_202



Please observe the instructions in the Workshop Manual.

Trapezoidal piston and trapezoidal conrod

During combustion of the fuel-air mixture, a high pressure is reached inside the combustion chamber. The component parts of the crankshaft drive are highly stressed due to the high combustion pressure.

To reduce the strain on the piston and conrod at high combustion pressures, the piston hub and the conrod eye are constructed trapezoidally.



223_228

In comparison with the conventional connection between piston and conrod, the contact surface of the conrod eye and piston hub on the piston pin has been enlarged

through its trapezoidal shape. Therefore, the combustion forces are distributed over a larger area. Less load is placed on the piston pin and conrod.

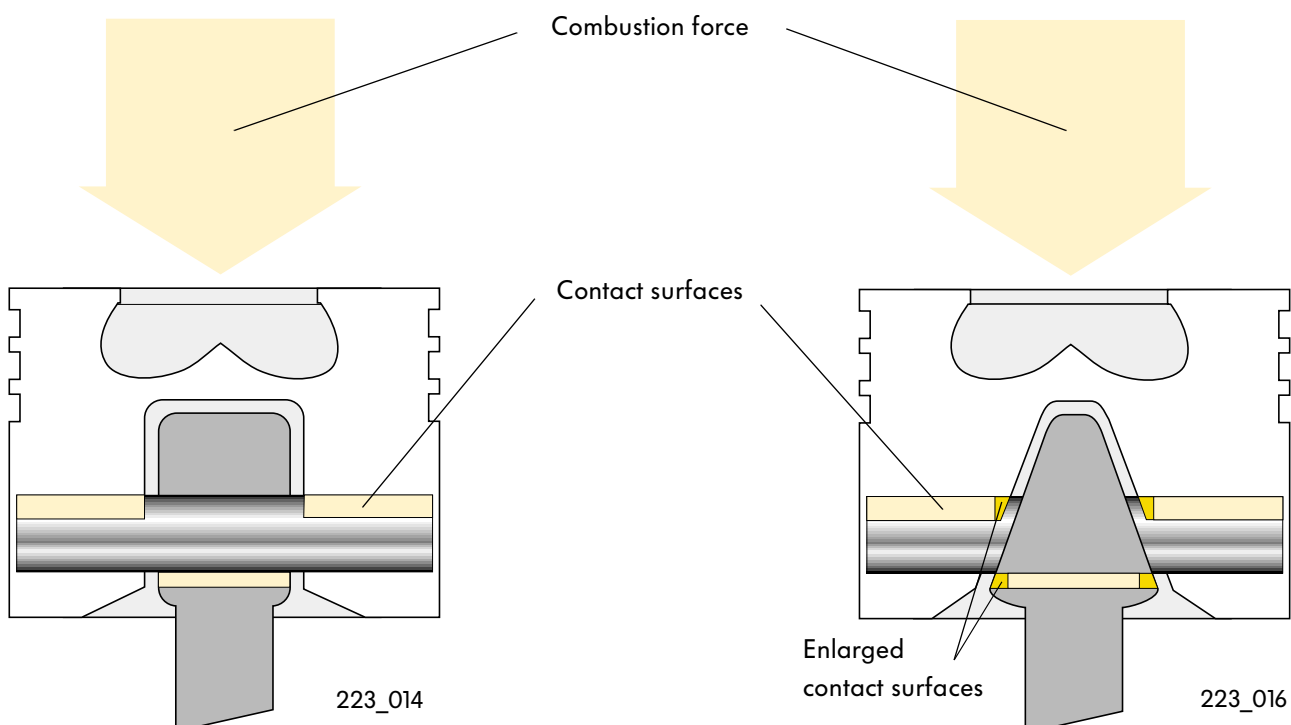

223_014

223_016

Engine mechanicals

The oil circuit

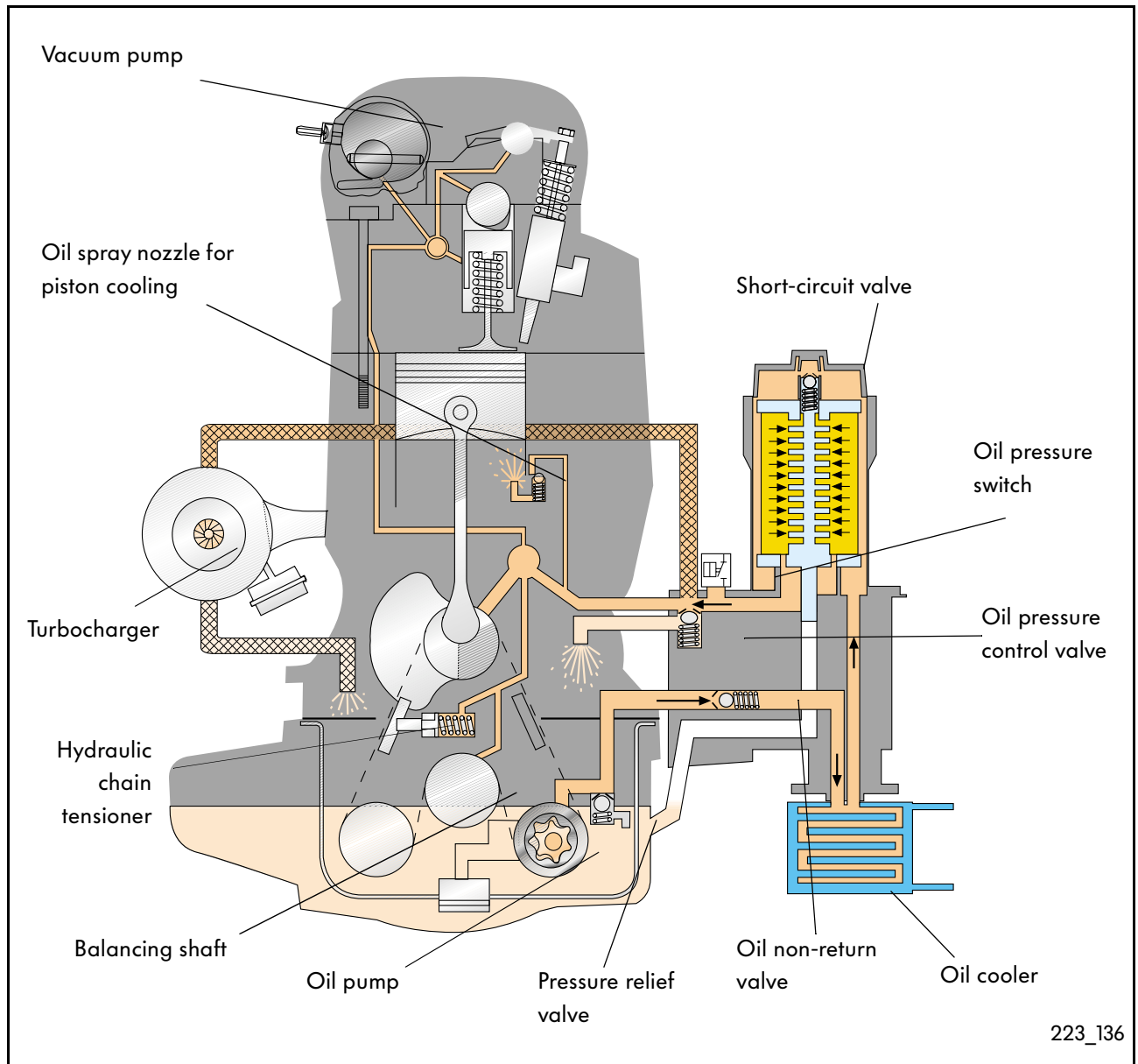

The pressure relief valve in the oil pump is a safety valve. It prevents damage to component parts of the engine due to excessively high oil pressure, for example at low ambient temperatures and high engine speeds.

The oil pressure control valve regulates the oil pressure of the engine. It opens as soon as the oil pressure reaches the max. permissible value.

The oil non-return valve stops oil running back out of the cylinder head and oil filter holder and into the oil sump when the engine is stationary.

The short-circuit valve opens when the oil filter is blocked and thereby safeguards the oil supply to the engine.

The oil filter holder

The oil filter holder is in an upright position. It has a paper filter element which can be replaced from above and is therefore easy to maintain and eco-friendly.

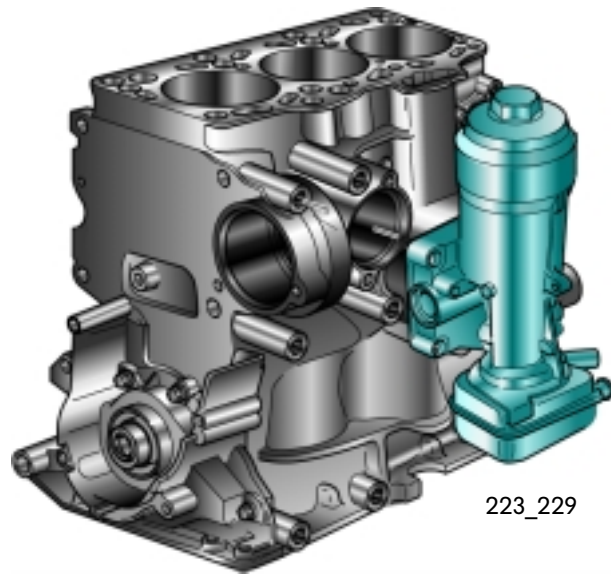

The oil pressure control valve and the oil non-return valve are integrated in the oil filter holder. The short-circuit valve is located in the sealing cover.

To ensure that oil drains out of the oil filter housing and into the oil sump when replacing the oil filter, a drilling is opened up when the paper filter element is removed. Through this drill hole, the oil can flow out of the filter housing via the cylinder block and into the oil sump.

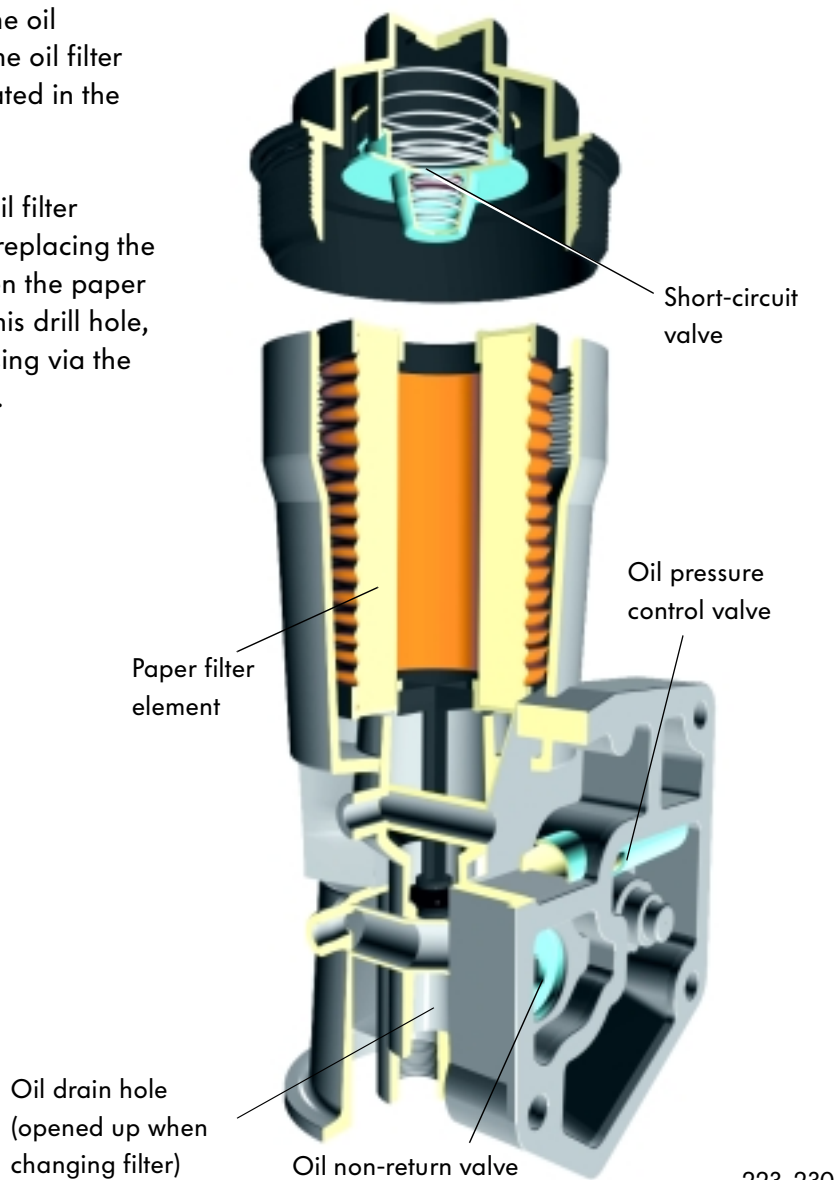

Engine mechanicals

The oil pump

The oil pump is an internal gear pump and is referred to as a duocentric pump. This concept describes the geometric shape of the gearing of the inner and outer rotors. The oil pump is attached to the ladder-type frame and is driven by the crankshaft by means of a chain. The chain is tensioned by a hydraulic chain tensioner.

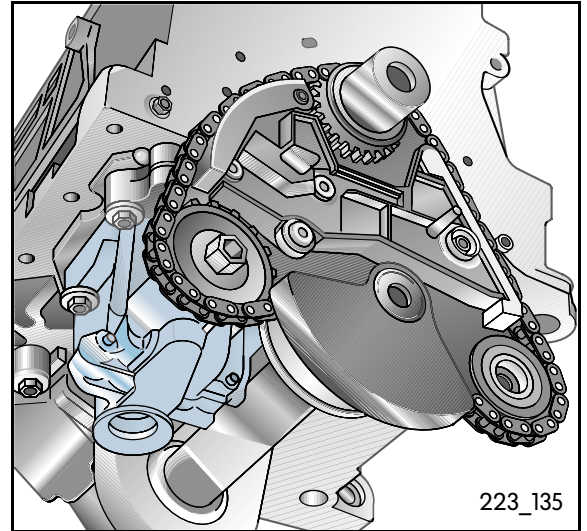

Mechanical construction of oil pump

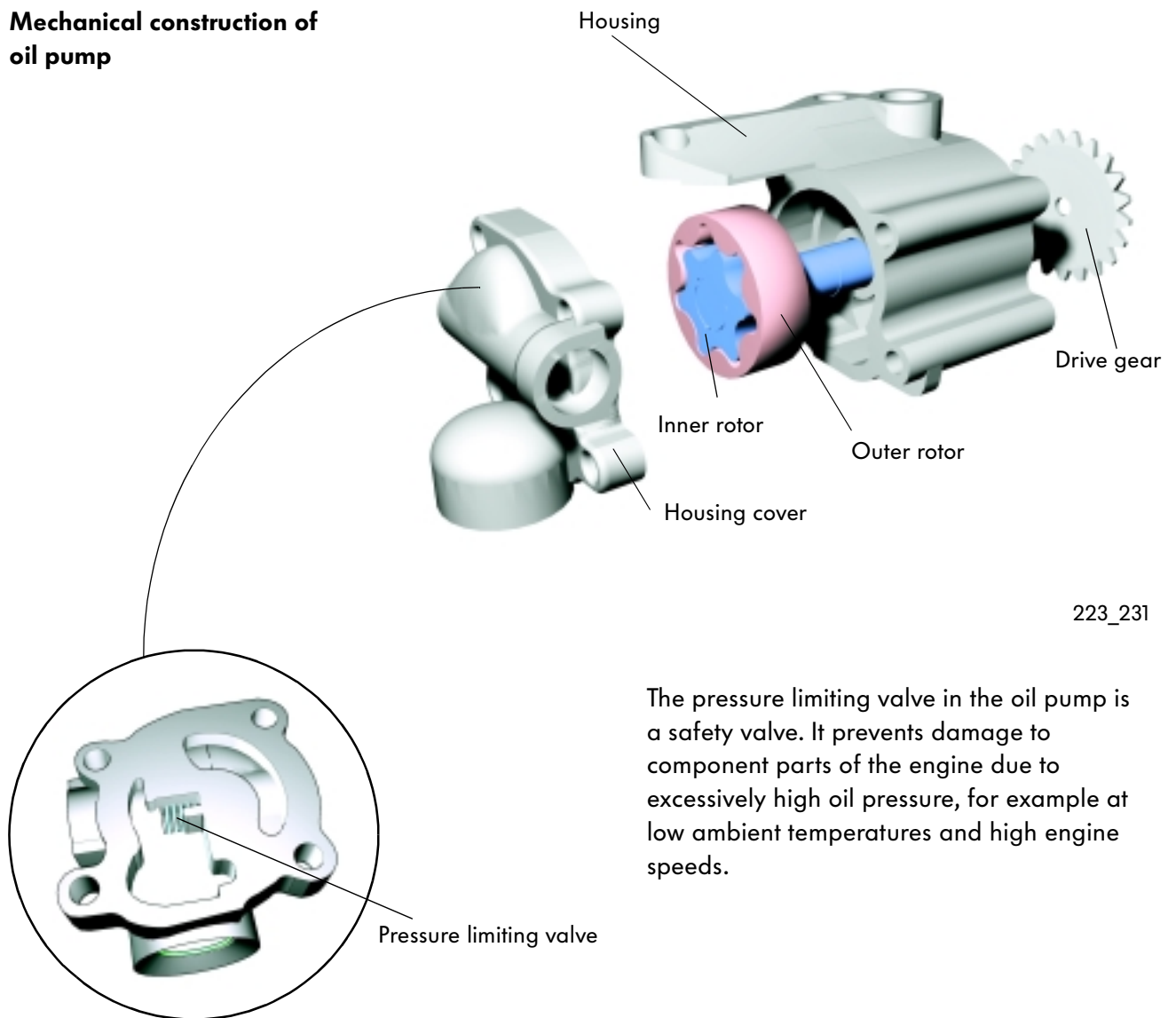

The pressure limiting valve in the oil pump is a safety valve. It prevents damage to component parts of the engine due to excessively high oil pressure, for example at low ambient temperatures and high engine speeds.

223_232

This is how it works:

Priming

The inner rotor is mounted on the input shaft and drives the outer rotor.

Due to the different rotational axes of the inner and outer rotors, the teeth diverge during the rotational movement producing an increase in volume on the suction side. As a result, the oil is drawn in along an intake line and conveyed to the pressure side.

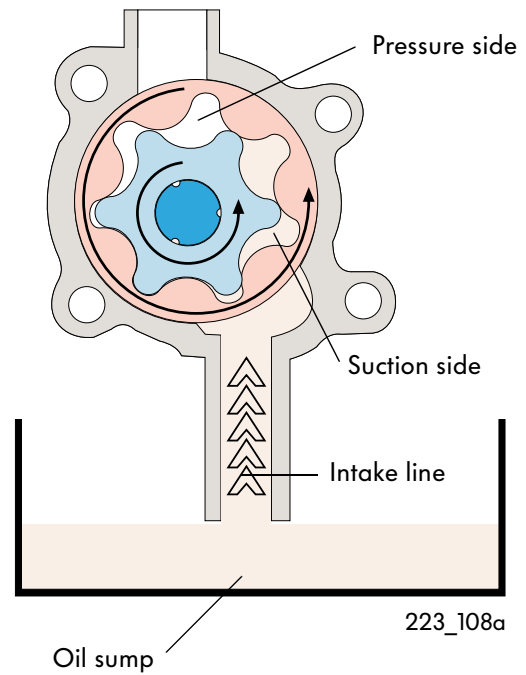

Producing pressure

On the pressure side, the teeth of the inner and outer rotors re-mate. This results in a decrease in volume between the teeth, forcing the oil into the engine's oil circuit.

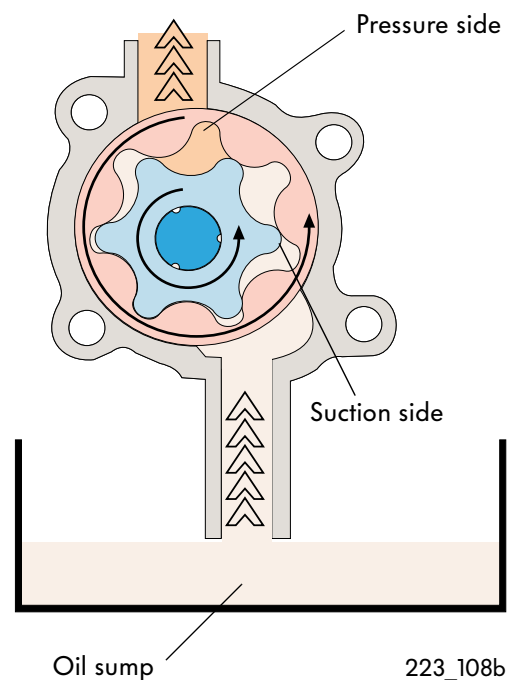

Engine mechanicals

Coolant circuit

On 1.2l TDI engine, the oil cooler is integrated in the large coolant circuit. Hence, the engine quickly reaches its operating temperature, helping to improve the fuel economy of the Lupo 3L.

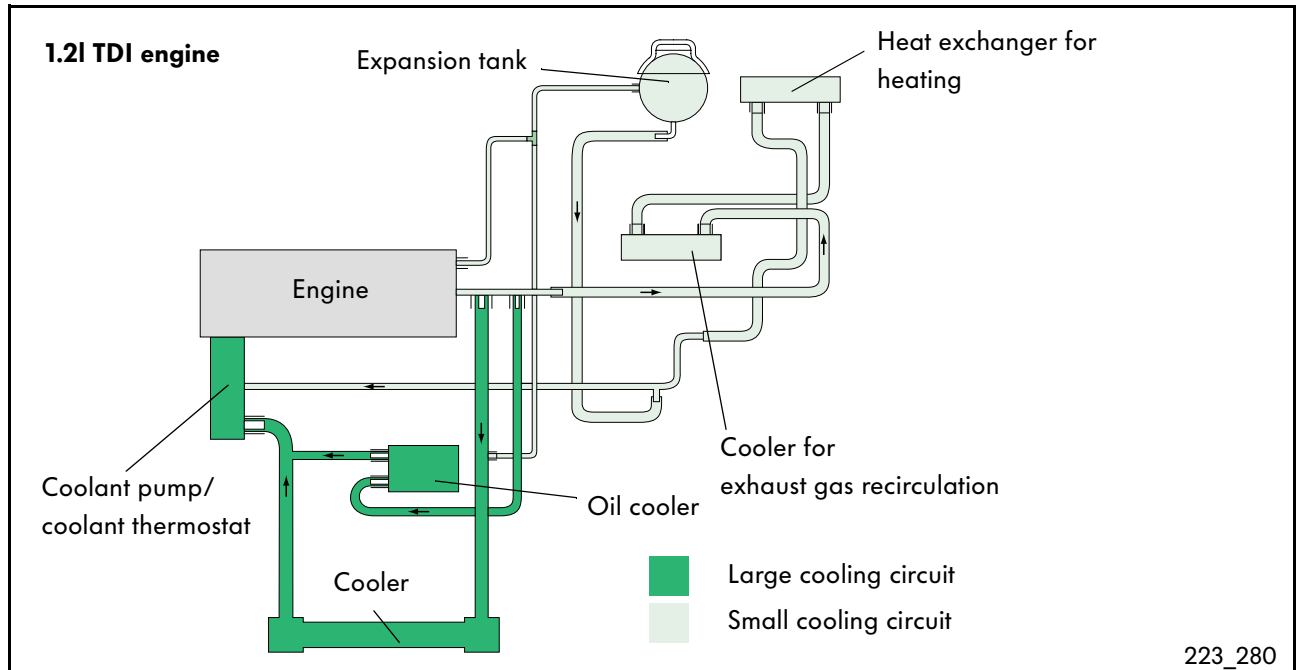
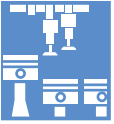

The oil cooler on the 1.4l TDI engine is located in the small coolant circuit.

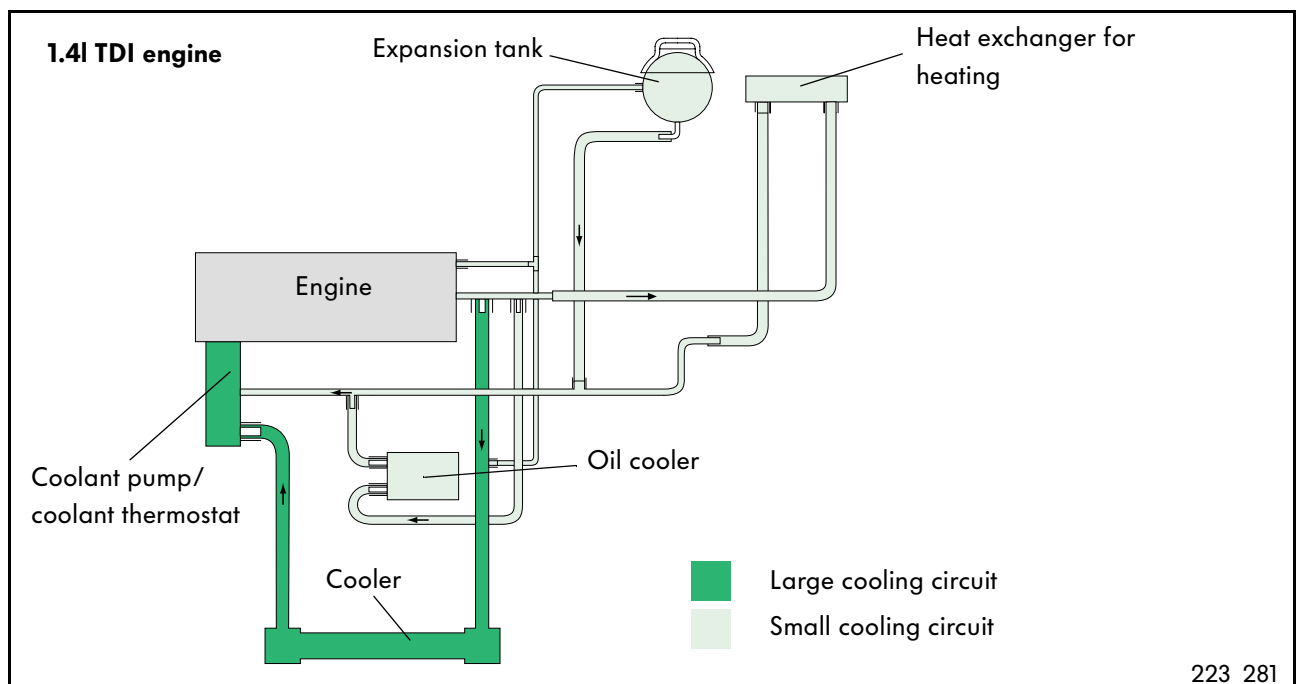

The toothed belt drive

Large drive forces are necessary to produce an injection pressure of 2000 bar. These forces place a heavy load on the component parts of the toothed belt drive.

For this reason, the following measures should be taken to relieve the load on the toothed belt:

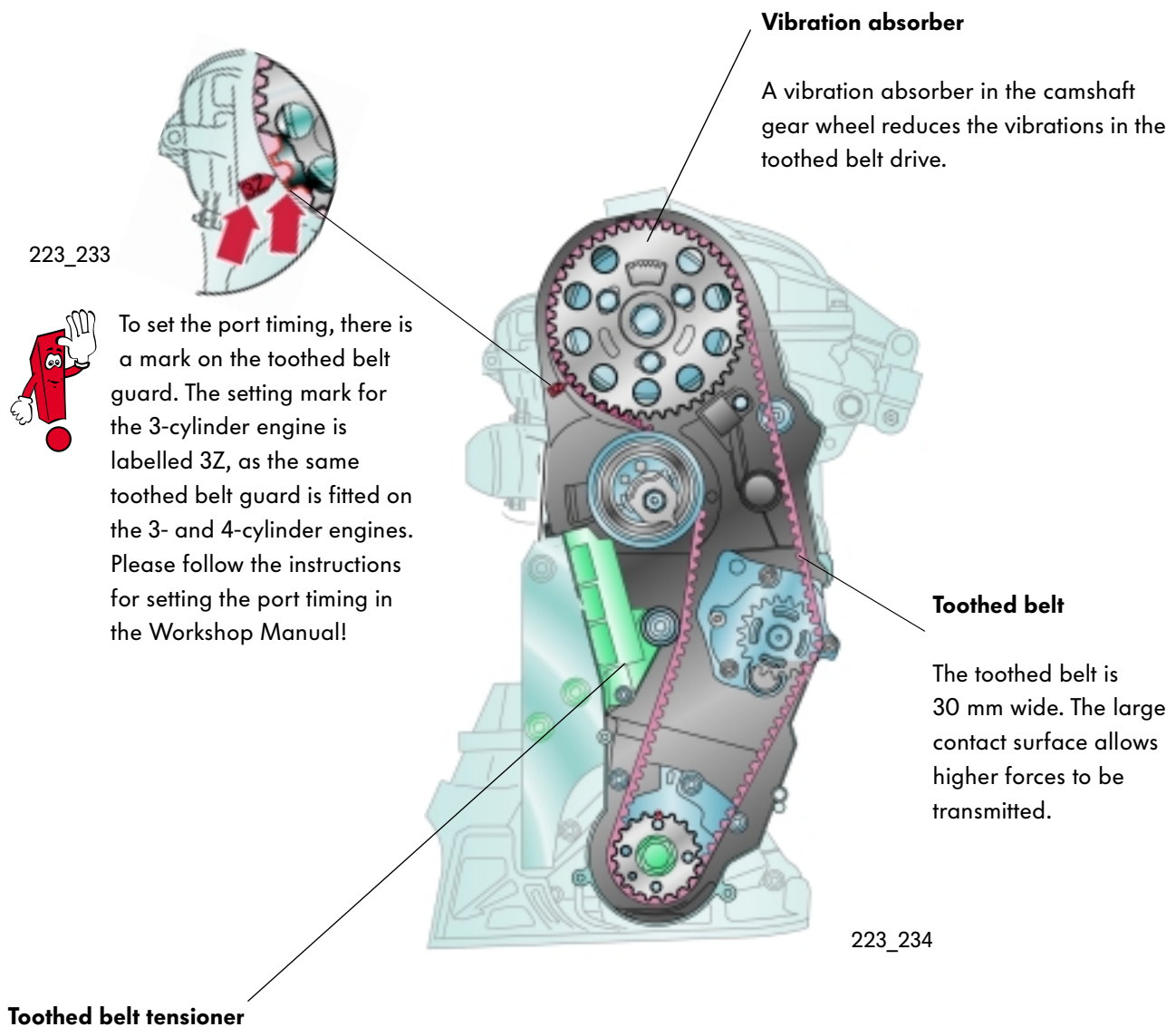
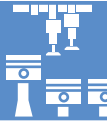

Engine mechanicals

The split camshaft gear

To simplify adjustment of the port timing, the camshaft and crankshaft can be fixed in the „top dead centre cylinder 1“ position using special tools. A split camshaft gear is used for this purpose. An integral part of the camshaft gear, the wheel hub is seated on the camshaft taper.

The installed position is defined by a tongue and groove joint. The other part is the camshaft gear which is attached to the wheel hub with bolts. The camshaft is fixed in the „TDC cylinder 1 position“ by inserting rig pin 3359 into a drill hole in the wheel hub and cylinder head.

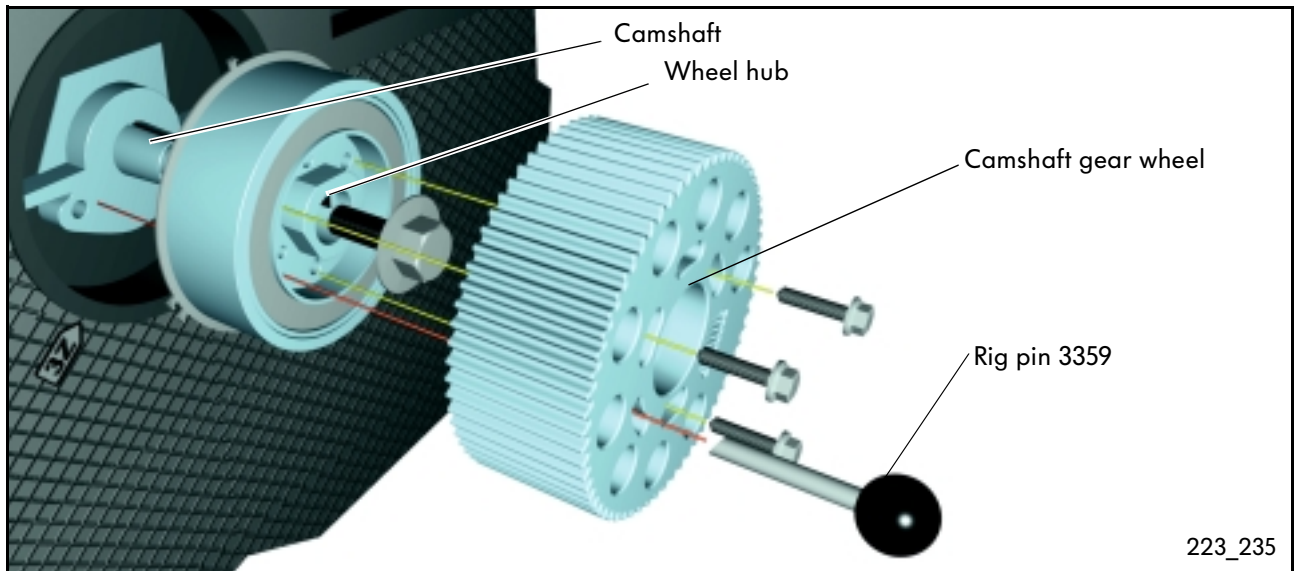

The crankshaft is fixed in the „TDC cylinder 1 position“ with crankshaft stop T 10050, which is pushed onto the crankshaft gear in an axial direction.

When tensioning the toothed belt, the camshaft gear is rotated in the oblong holes, and the camshaft is arrested in the TDC cylinder 1 position by rig pin 3359.

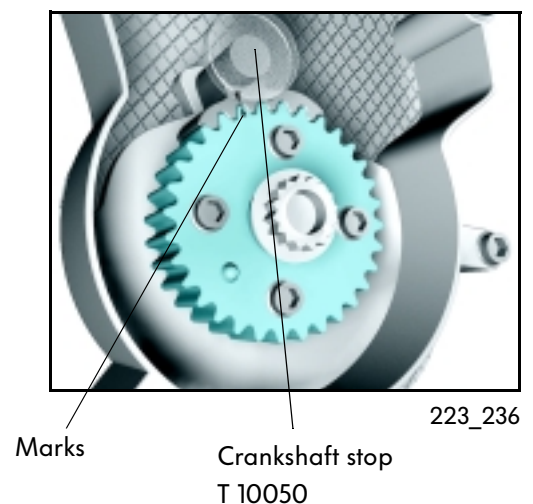

Unit injector system

General

What is a unit injector?

A unit injector is, as the name already implies, an injection pump combined with a solenoid valve and injector to form a unit. Each engine cylinder has a unit injector. Eliminating the high-pressure line produces a small high-pressure volume, allowing a high maximum injection pressure to be reached.

Pressure build-up, commencement of fuel injection and injection quantity are precisely controlled by the engine management system by means of solenoid valves. This makes for good mixture formation, and hence effective combustion of the fuel-air mixture. The result is high efficiency and low pollutant emission allied to good fuel economy.

The unit injectors are directly integrated in the cylinder head, where they are secured by clamping blocks.

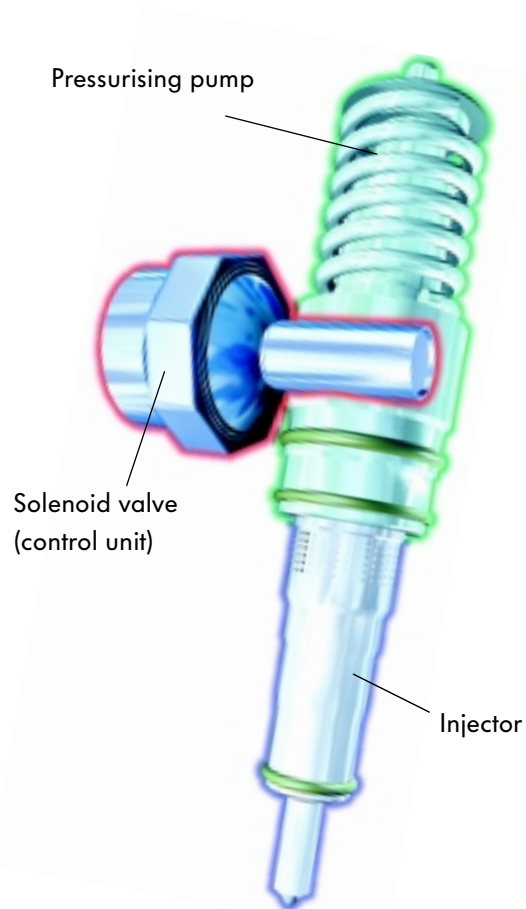

223_237

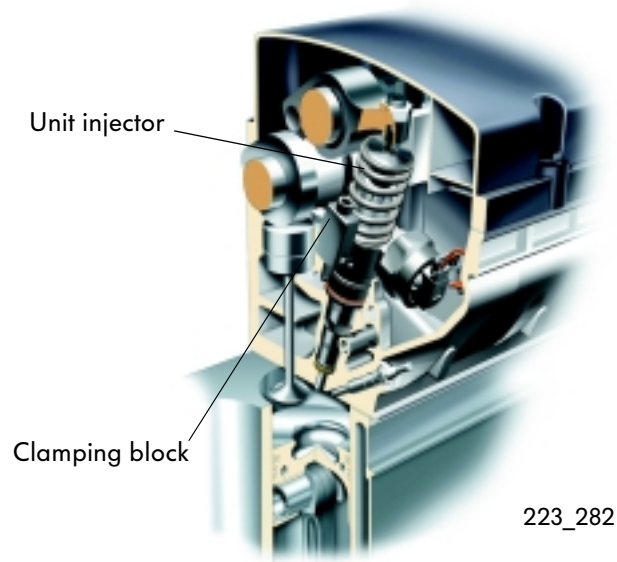

223_282



When installing the unit injector, it is important to ensure that it is in the correct position. If the unit injector is not at right angles to the cylinder head, then the fastening bolt may work itself loose. As a result, the unit injector and/or the cylinder head can become damaged. Please follow the instructions in the Workshop Manual.

Unit injector system

Mechanical construction

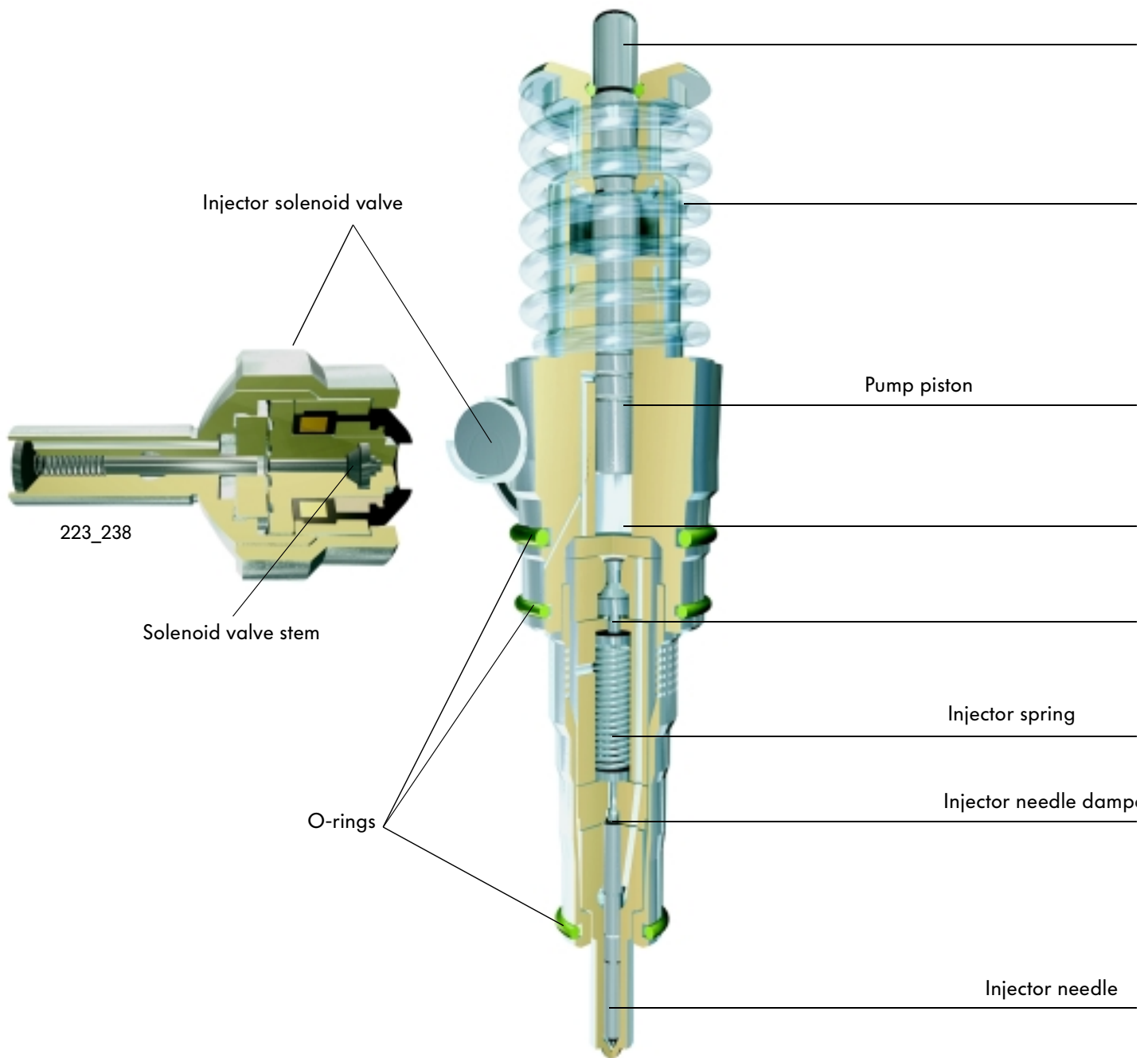
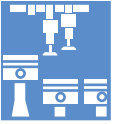

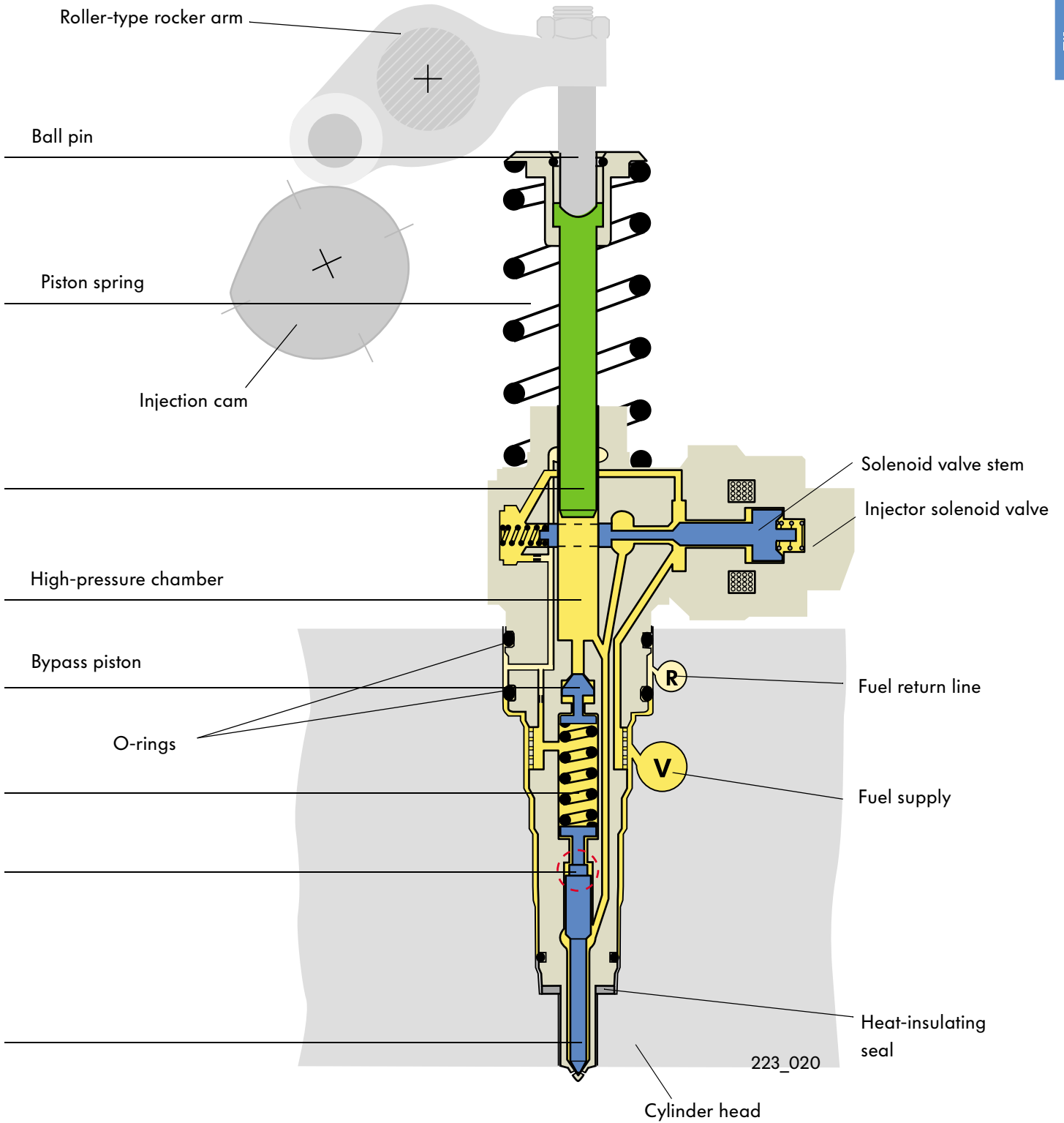
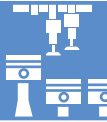

Unit injector system

Drive

The camshaft has three injection cams for driving the unit injector. They actuate the pump pistons of the unit injectors by means of roller-type rocker arms.

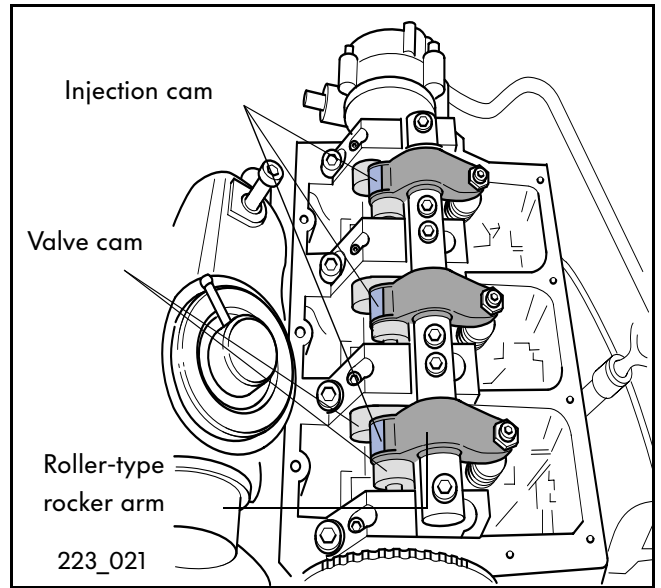
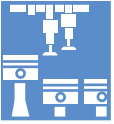

Cam shape

The injection cam has a steep leading edge. As a result, the pump piston is pushed down at high speed, producing a high injection pressure very quickly.

The upward stroke of the pump piston is slow and steady due to its flat trailing edge. This ensures that the fuel which flows into the high-pressure chamber of the unit injector is free from bubbles.

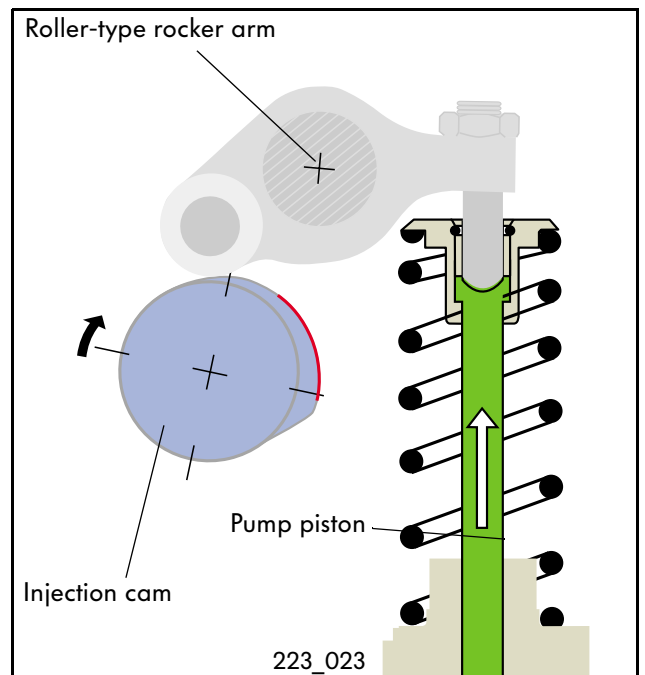
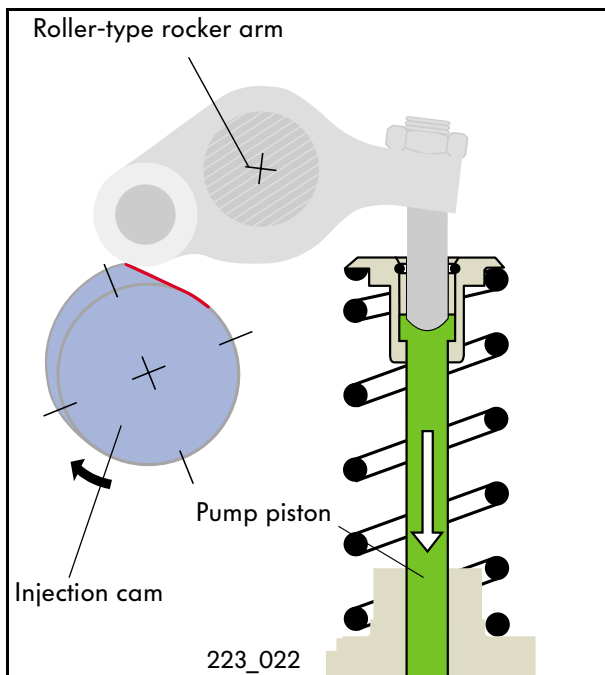

On the following pages, we will explain the function and individual phases of the injection cycle. The phases are subdivided as follows:

- Filling of the high-pressure chamber
- Commencement of pre-injection cycle
- End of pre-injection cycle
- Commencement of main injection cycle
- End of main injection cycle

The high-pressure chamber is filled

During the filling cycle, the pump piston rises under the force of the piston spring and thus enlarges the volume of the high-pressure chamber. The injector solenoid valve is not activated.

The solenoid valve stem is in the resting position and opens up the path from the fuel supply to the high-pressure chamber. The fuel pressure in the supply line causes the fuel to flow into the high-pressure chamber.

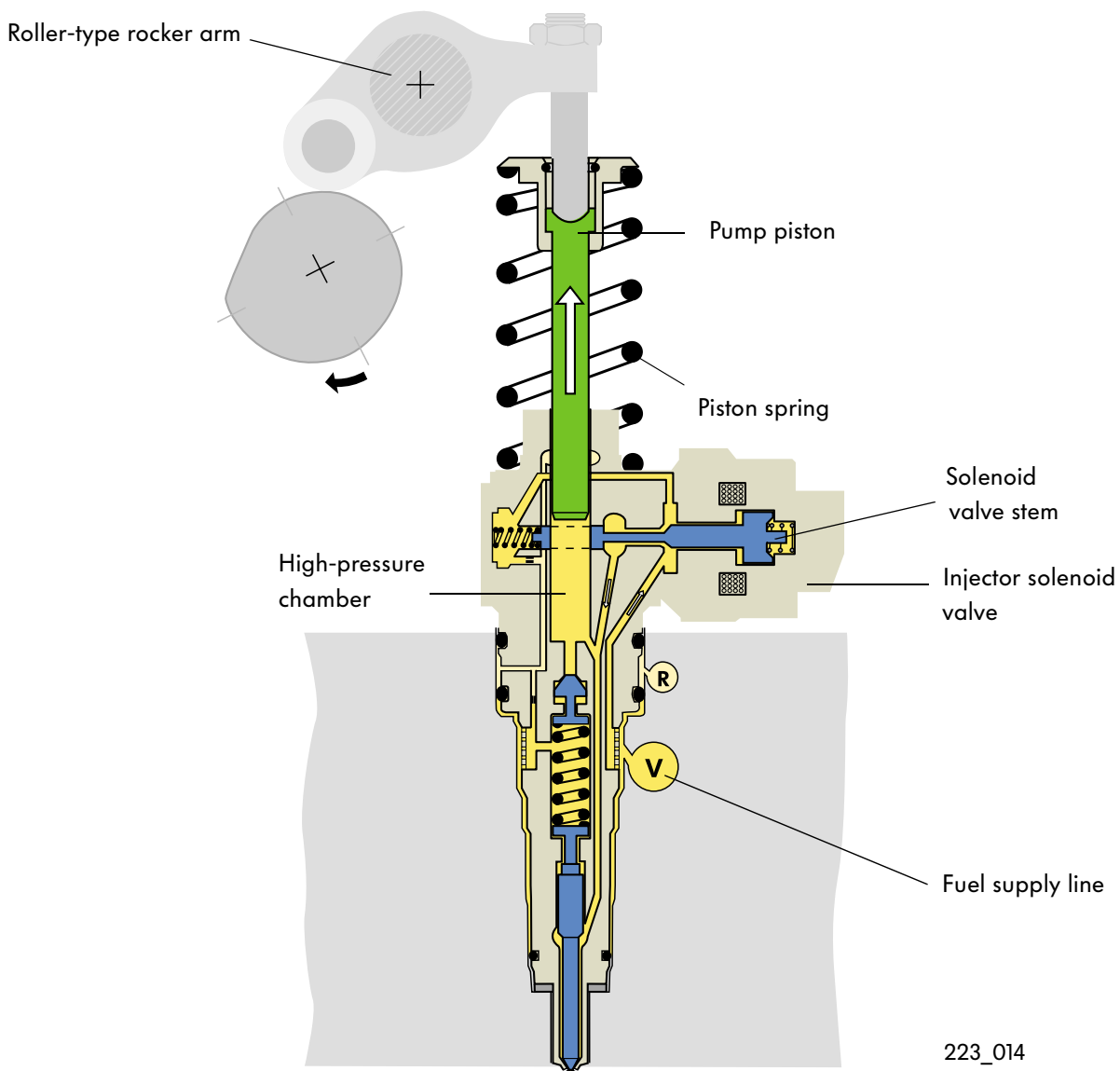

223_014

Unit injector system

Commencement of pre-injection cycle

The pump piston is pressed down by the injection cam via the roller-type rocker arm, and thus displaces the fuel from the high-pressure chamber into the fuel supply line.

The engine control unit initiates the injection cycle. For this purpose, the engine control unit activates the injector solenoid valve.

The solenoid valve stem is pressed into the seat and closes off the path from the high-pressure chamber to the fuel supply line. As a result, pressure begins to build up inside the high-pressure chamber. At 180 bar, the pressure is greater than the force of the injector spring. The injector needle is lifted and the pre-injection cycle commences.

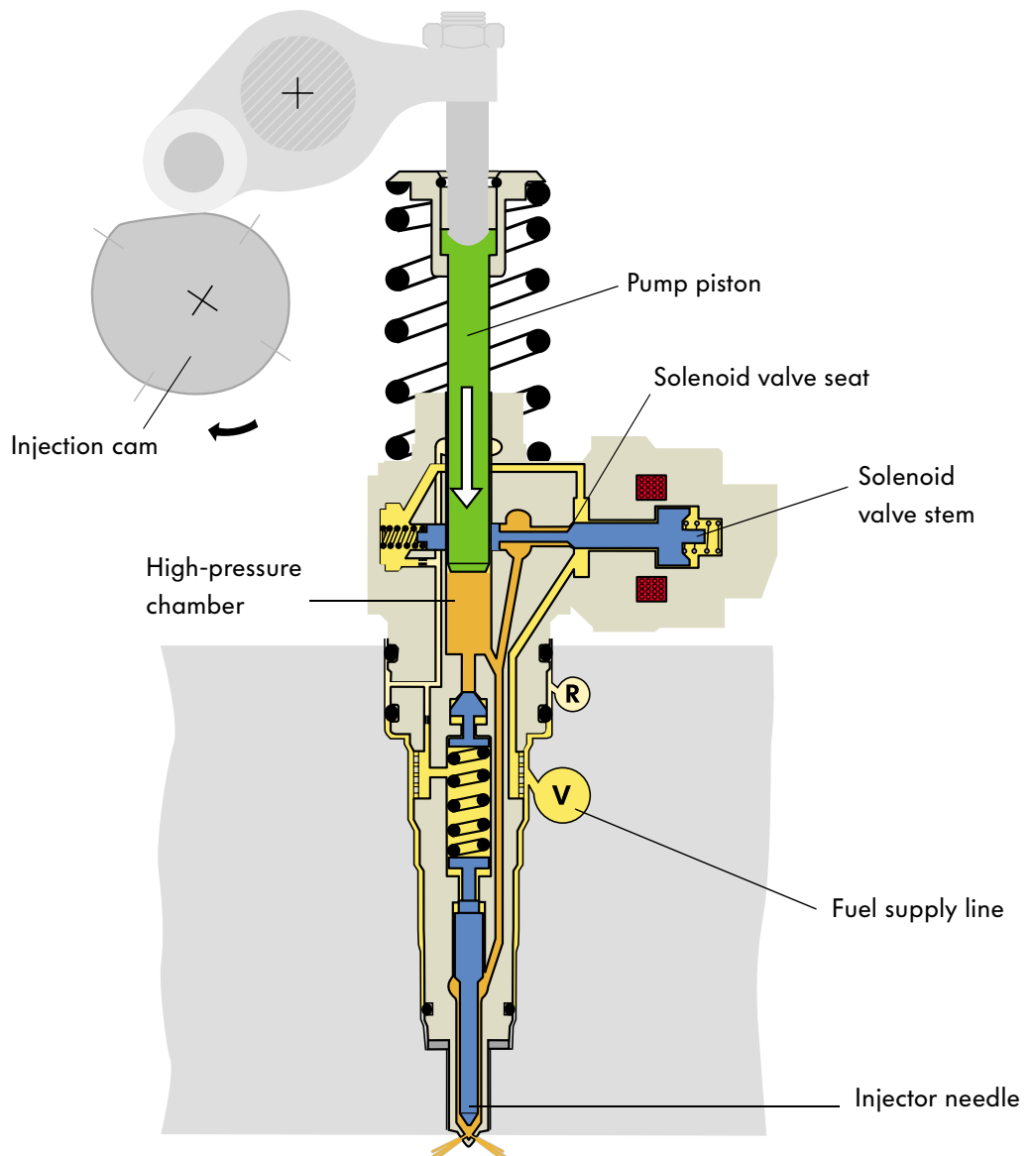

223_015

Injector needle damper

During the pre-injection cycle, the stroke of the injector needle is damped by a hydraulic „cushion“. This makes it possible to meter the injection quantity exactly.

This is how it works:

During the first third of the overall stroke, the injector needle is opened undamped and the pre-injection quantity is injected into the combustion chamber.

As soon as the damping piston plunges into the drill hole in the injector housing, the fuel can only be displaced above the injector needle via a leak gap in the injector spring chamber. This produces a hydraulic „cushion“ which restricts the stroke of the injector needle during the pre-injection cycle.

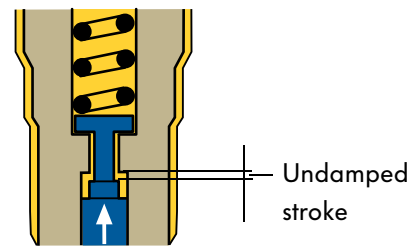

223_165

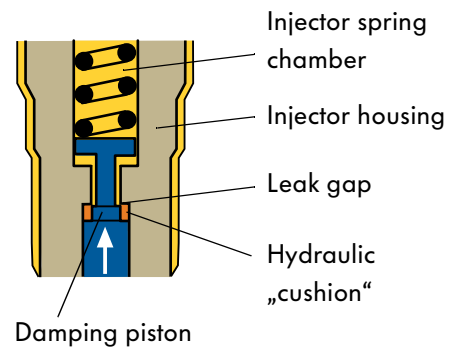

223_166



Unit injector system

End of pre-injection cycle

The pre-injection cycle ends directly after the injector needle opens. The rising pressure causes the bypass piston to move down, thereby increasing the volume of the high-pressure chamber.

The pressure drops briefly as a result and the injector needle closes.

The pre-injection cycle is completed.

The downwards movement of the bypass piston increases the preload on the injector spring. The fuel pressure required to reopen the injector needle during the subsequent main injection cycle, therefore, is higher than during the pre-injection cycle.

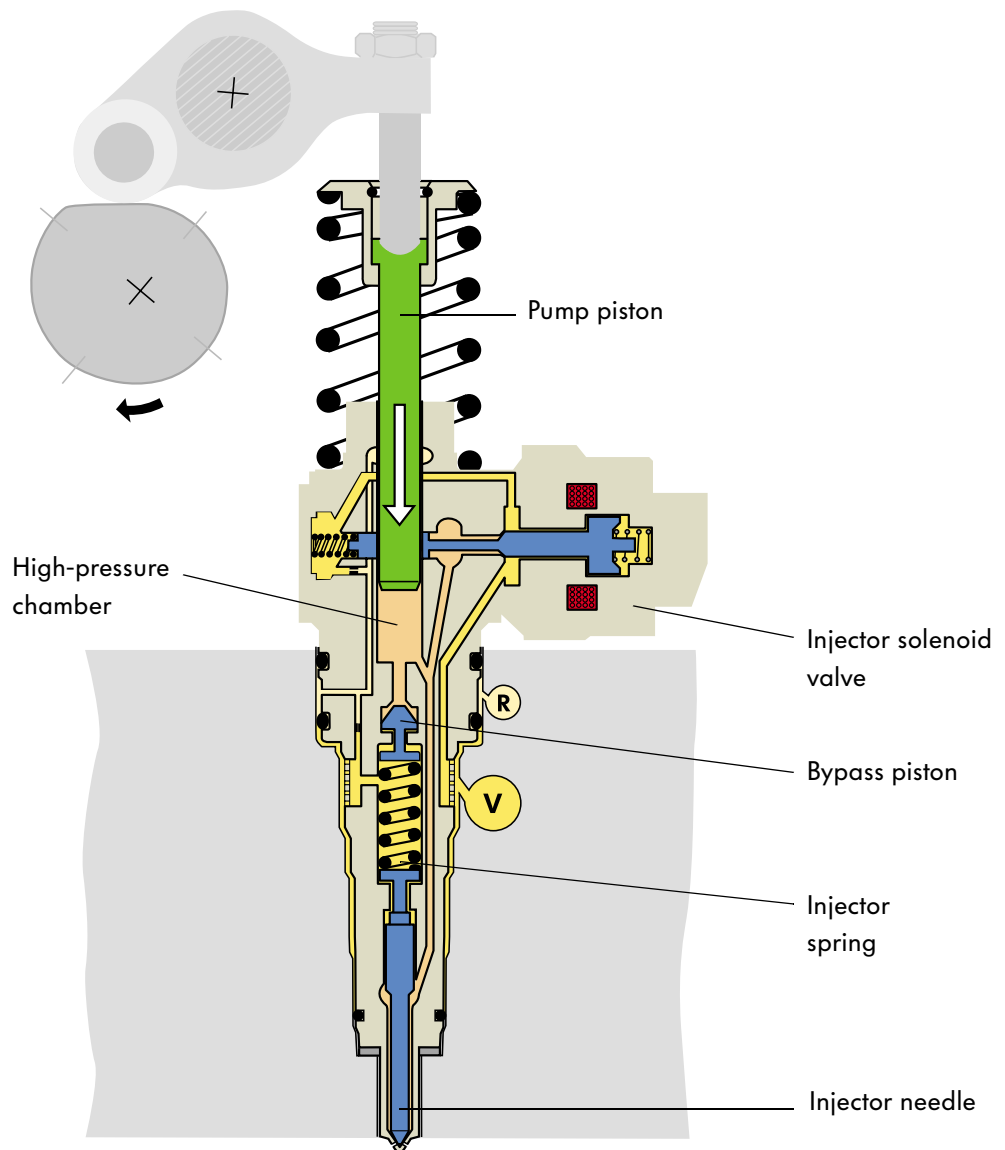
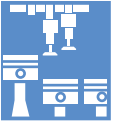

Commencement of main injection cycle

Shortly after the injector needle closes, the pressure again rises inside the high-pressure chamber. The injector solenoid valve remains closed and the pump piston moves downwards. At approx. 300 bar, the fuel pressure is greater than the force of the preloaded injector spring. The injector needle is again raised and the main injection quantity is injected.

The pressure rises up to 2050 bar, because more fuel is displaced inside the high-pressure chamber than can escape through the nozzle holes. Peak pressure is at maximum engine power output, i.e. at a high engine speed and large injection quantity.

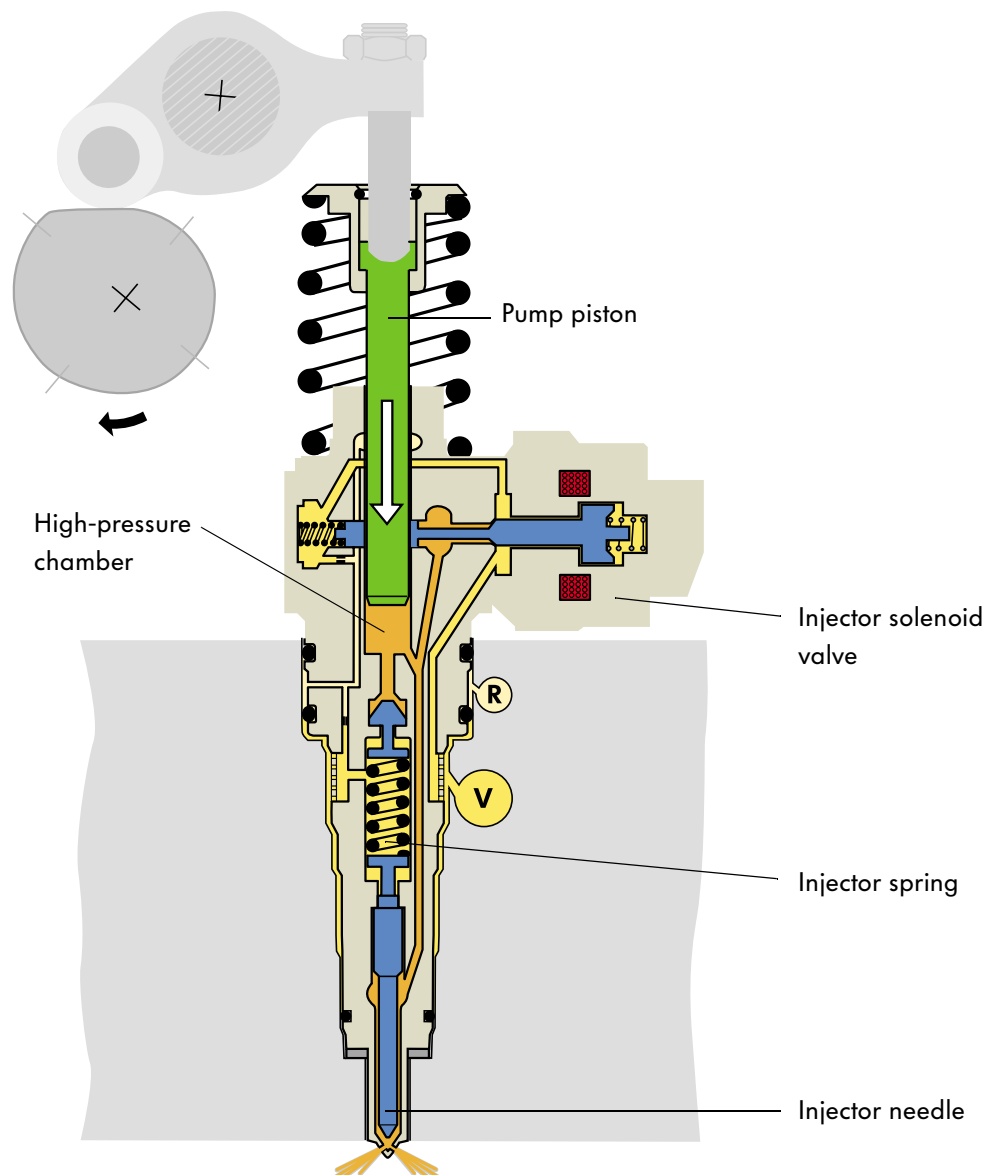

223_017

Unit injector system

End of main injection cycle

The injection cycle is terminated when the engine control unit no longer actuates the injector solenoid valve. The solenoid valve stem is opened by the solenoid valve spring and the fuel displaced by the pump piston can escape into the fuel supply line. The pressure drops.

The injector needle closes and the bypass piston is pressed into its initial position by the injector spring.

The main injection cycle is now completed.

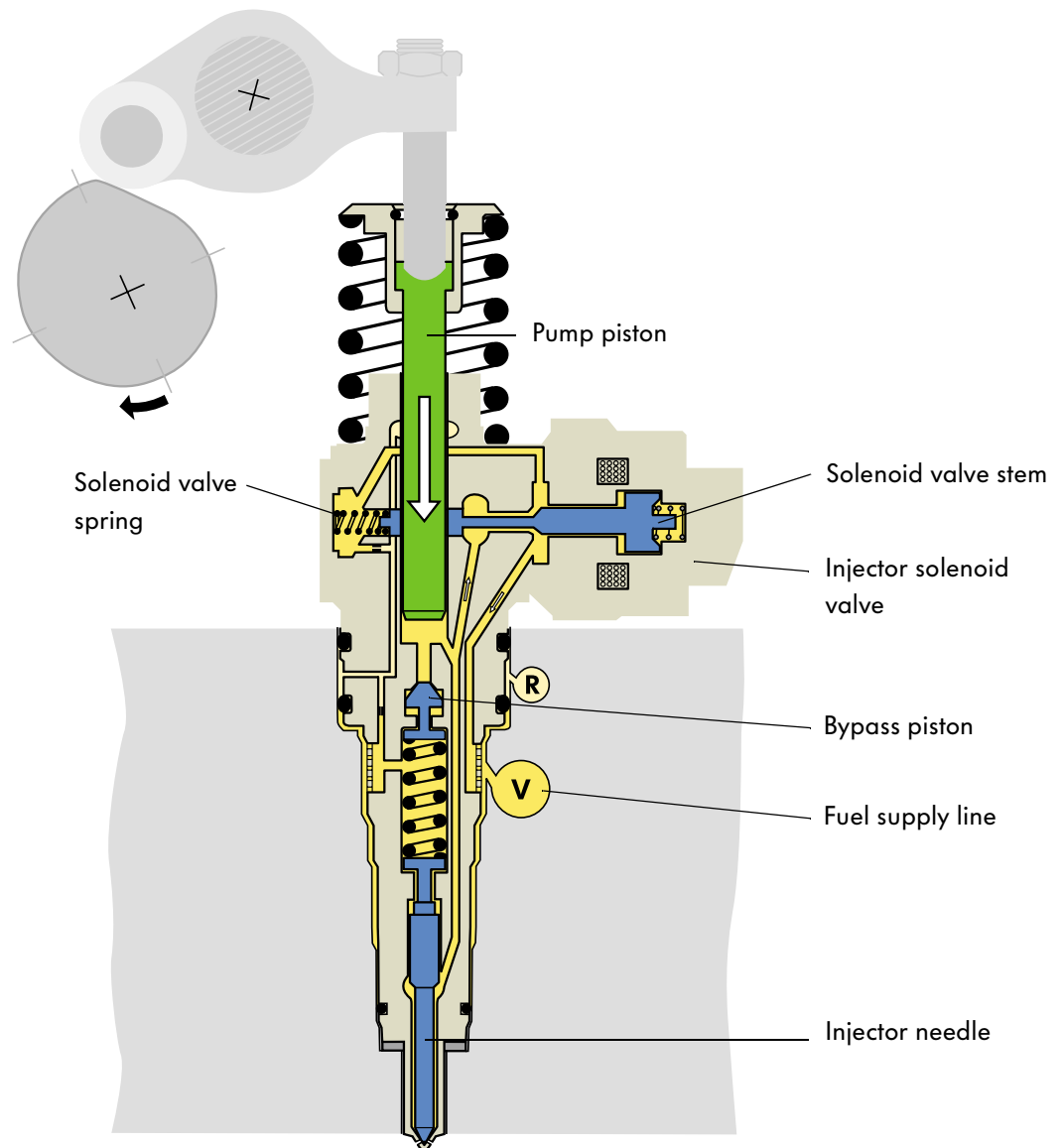

The fuel return line in the unit injector

The fuel return line in the unit injector has the following tasks:

- Cooling the unit injector. For this purpose, fuel is flushed from the fuel supply line through the ducts of the unit injector and into the fuel return line.
- Discharge of the leaking fuel from the pump piston.
- Separation of vapour bubbles from the fuel supply via the restrictor into the fuel return line.

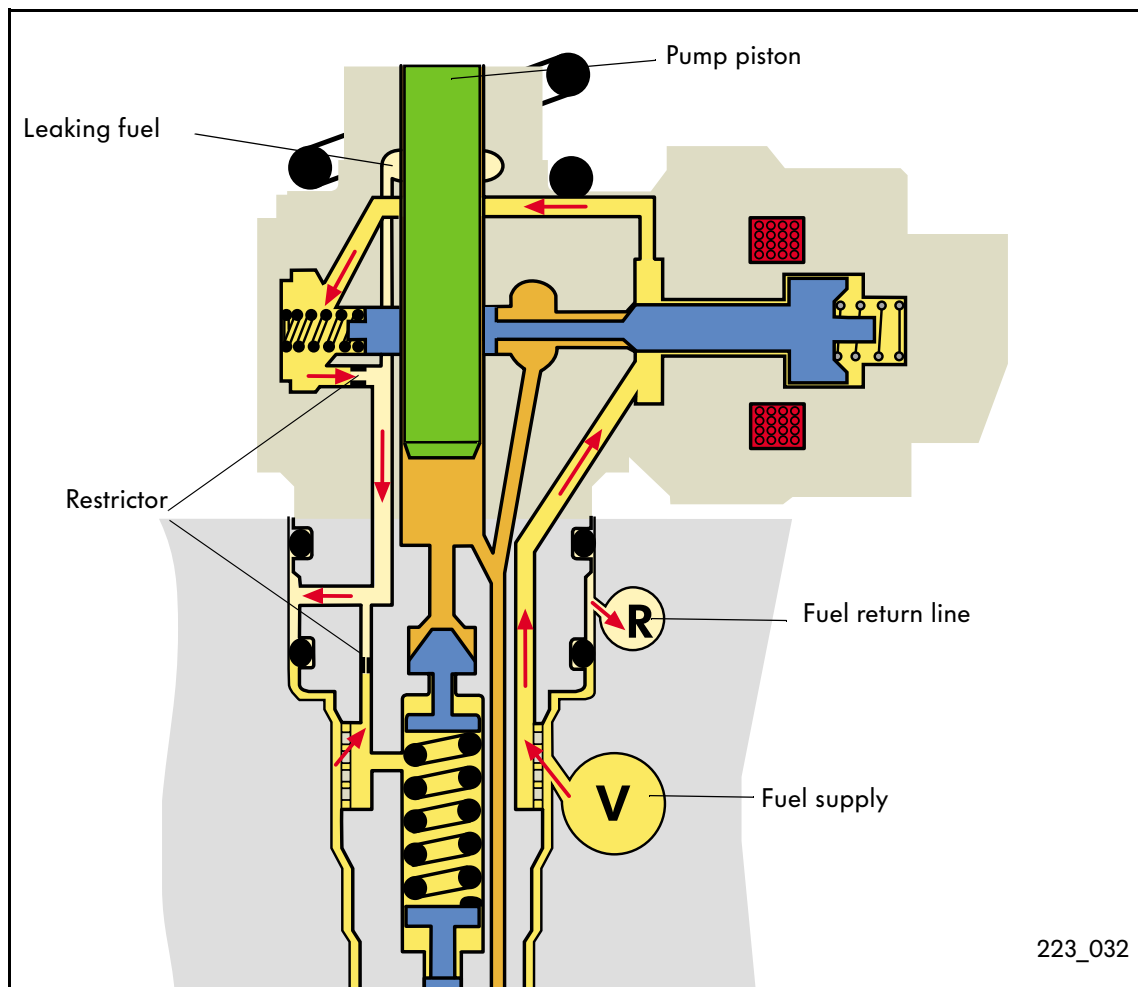

Fuel supply line

The fuel system

The fuel is drawn out of the fuel tank through the fuel filter by a mechanical fuel pump and pumped along the supply line in the cylinder head to the unit injector (on the 1.4l TDI engine, an electrical fuel pump pumps the fuel from the fuel tank to the mechanical fuel pump).

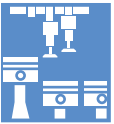

The fuel pre-heating valve

On the 1.2l TDI engine, the fuel pre-heating valve does not open up the path to the fuel tank until the fuel temperature exceeds 60°C (1.4l TDI engine >30°C). As a result, the heat is concentrated on the engine and the engine reaches operating temperature more quickly.

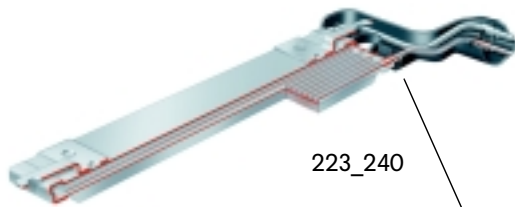

The fuel cooler

cools the returning fuel so the fuel tank is not exposed to excessively hot fuel.

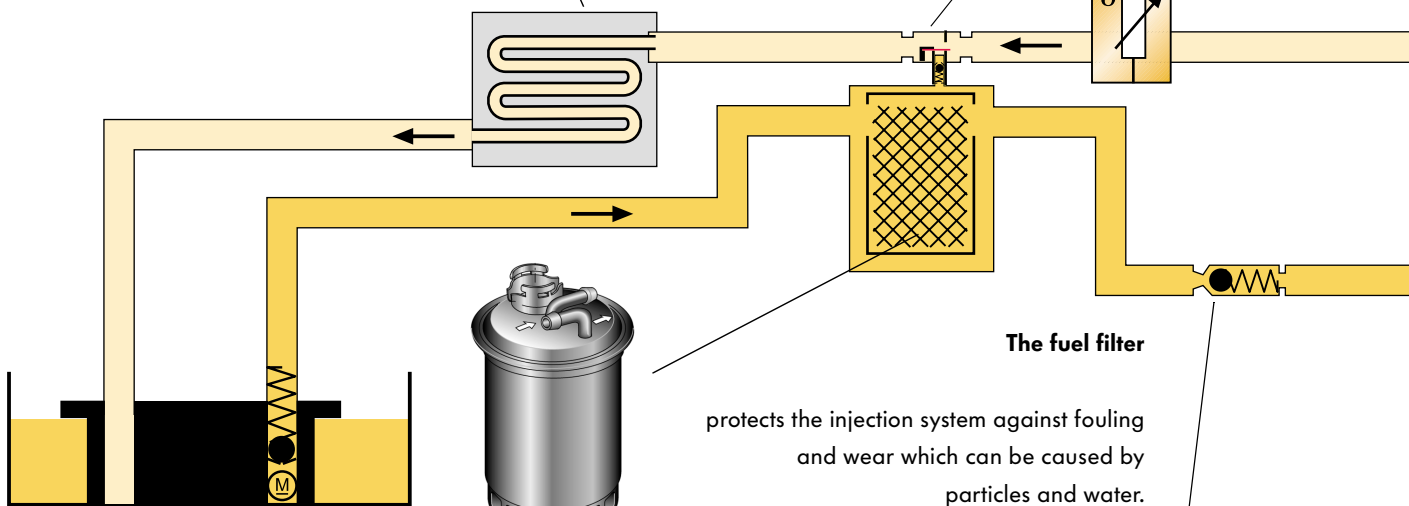
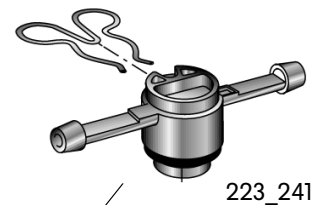

The fuel filter

protects the injection system against fouling and wear which can be caused by particles and water.

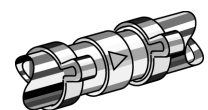

The non-return valve

prevents fuel flowing back from the fuel pump into the fuel tank when the engine is stationary (opening pressure=0.2 bar).

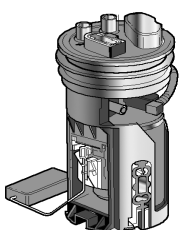

The electrical fuel pump

operates as a pre-supply pump and pumps fuel to the mechanical fuel pump.

223_260

The fuel which is not required for injection flows from the unit injector back into the fuel tank along the return line in the cylinder head, the fuel pump and the fuel cooler.

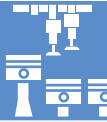

The fuel temperature sensor

is used for fuel temperature measurement by the engine control unit.

The pressure limiting valve

maintains a constant pressure of 1 bar in the fuel return line. This results in a force equilibrium at the solenoid valve stem.

The bypass

If there is air in the fuel system - this can occur, for example, when the fuel tank is run empty - the pressure limiting valve remains closed. The incoming fuel expels the air from the system.

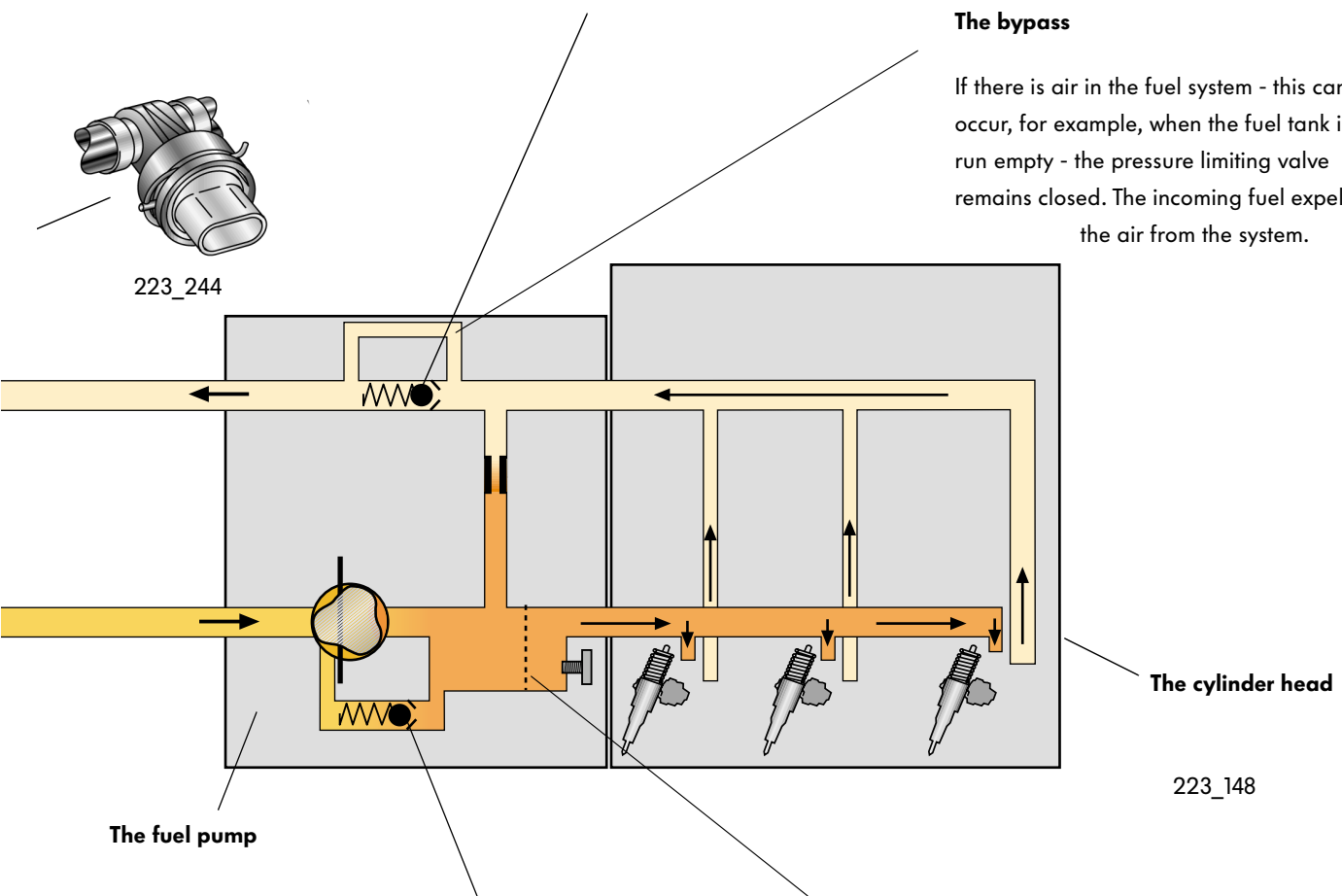

The fuel pump

The pressure limiting valve

regulates the fuel pressure in the fuel supply line. The valve opens at a fuel pressure of 7.5 bar and the fuel is delivered to the suction side of the fuel pump.

The strainer

has the task of collecting vapour bubbles in the fuel supply line. The air bubbles are separated via the restrictor bore and return line.

Fuel supply

The fuel pump

The fuel pump is located directly behind the vacuum pump on the cylinder head. It draws the fuel out of the fuel tank and feeds it to the unit injector.

Both pumps are jointly driven by the camshaft, hence this unit is referred to as a „tandem pump“.

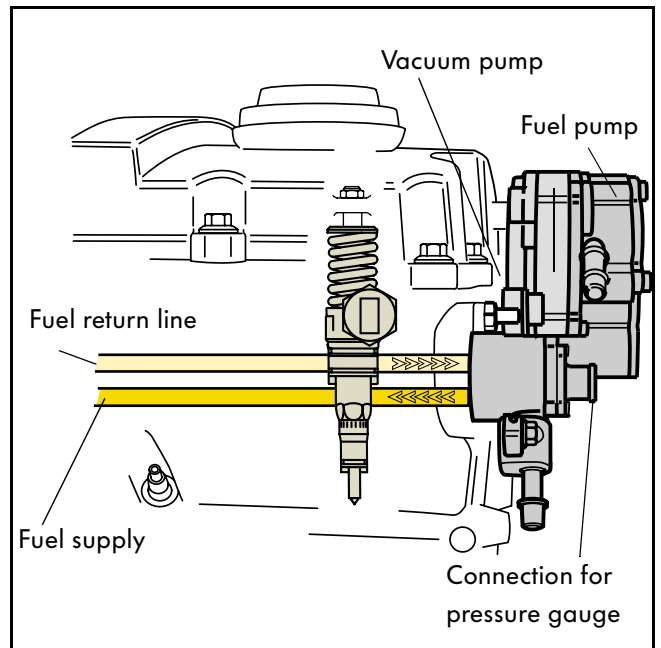

223_128



There is a connection on the fuel pump for pressure gauge VAS 5187, which can be used to check the fuel pressure in the supply line. Please follow the instructions in the Workshop Manual.

The fuel pump is a blocking vane-cell pump. One of the characteristic features of this pump type is that the blocking vanes are pressed against the rotor by a spring force. This has the advantage that the fuel pump delivers fuel even at low engine speeds. The fuel ducting within the pump is designed in such a way that the rotor is kept constantly wetted with fuel - even when the tank is empty. Automatic priming is thus possible.

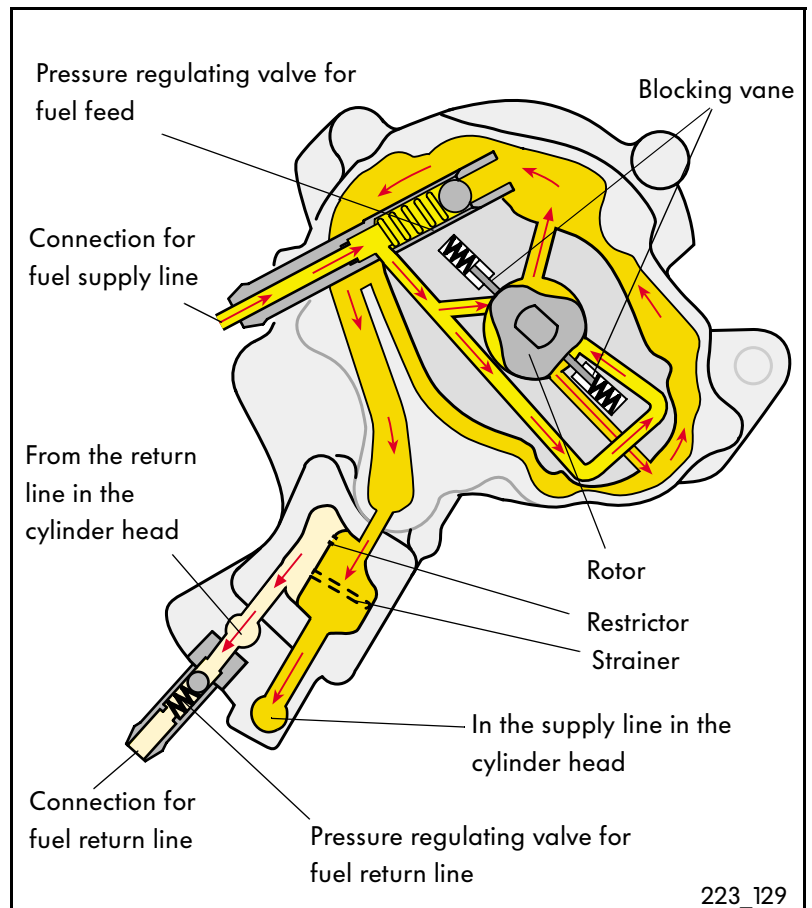

223_129

The distributor pipe

There is a distributor pipe in the supply line in the cylinder head. It has the task of distributing the fuel evenly to the unit injectors.

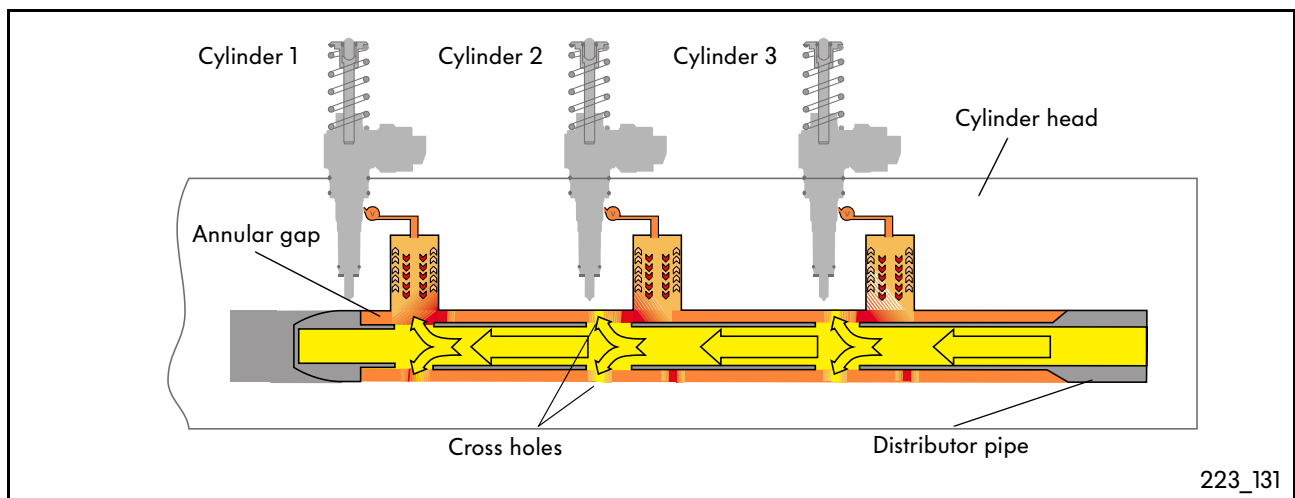
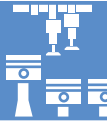
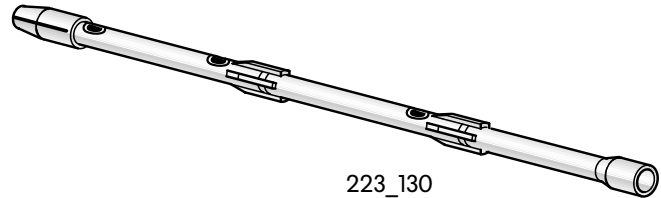

This is how it works:

The fuel pump feeds the fuel into the supply line in the cylinder head. Here, the fuel flows towards cylinder 1 the along the inner side of the distributor pipe. The fuel enters the annular gap between the distributor pipe and the cylinder head wall through cross holes. Here, the fuel is mixed with the hot fuel pushed back into the supply line by the unit injectors. This results in a constant fuel temperature in the supply lines to all cylinders. All unit injectors are supplied with the same fuel mass. This ensures that the engine runs smoothly.

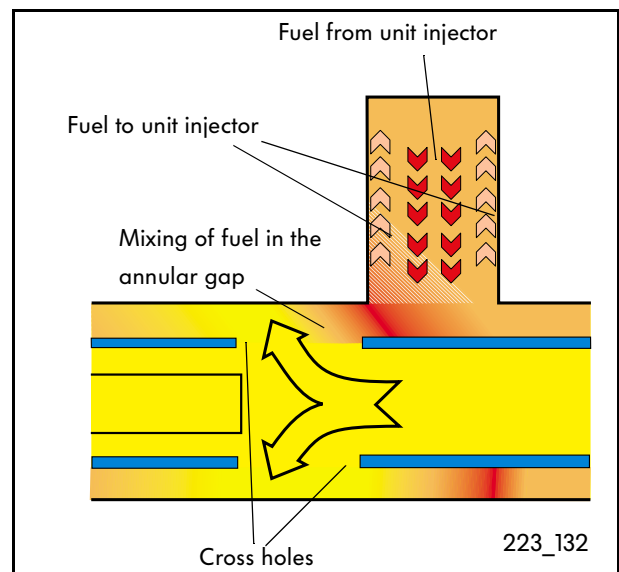

Fuel supply

The electrical fuel pump

The electrical fuel pump is located in the fuel tank and functions as a pre-supply pump. It pumps fuel to the mechanical fuel pump on the cylinder head. This ensures that vapour bubbles cannot form in extreme situations due to excessively high vacuum in the fuel supply (e.g. driving at high speed at warm ambient temperatures). Irregularities in engine running due to vapour bubble formation are thus prevented.

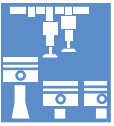

This is how it works:

Electrical principle

When the ignition is turned on, the fuel pump relay is activated by the engine control unit and switches the working current for the fuel pump. The pump runs for approx. 2 seconds and builds up a pilot pressure. During the pre-heating phase, the pump is switched off in order to relieve the load on the starter battery. The pump runs continuously as soon as the engine begins to turn.

Hydraulic principle

The fuel pump draws the fuel out of the reservoir through a filter. The fuel feed is proportioned in the pump cover. One part is fed into the supply to the engine and the other part is fed into the suction jet pump drive. The suction jet pump draws the fuel out of the fuel tank and pumps it into the fuel pump's reservoir. The pressure limiting valve in the pump cover limits the feed pressure to 0.5 bar. This protects the fuel lines from exposure to excessively high fuel pressures.

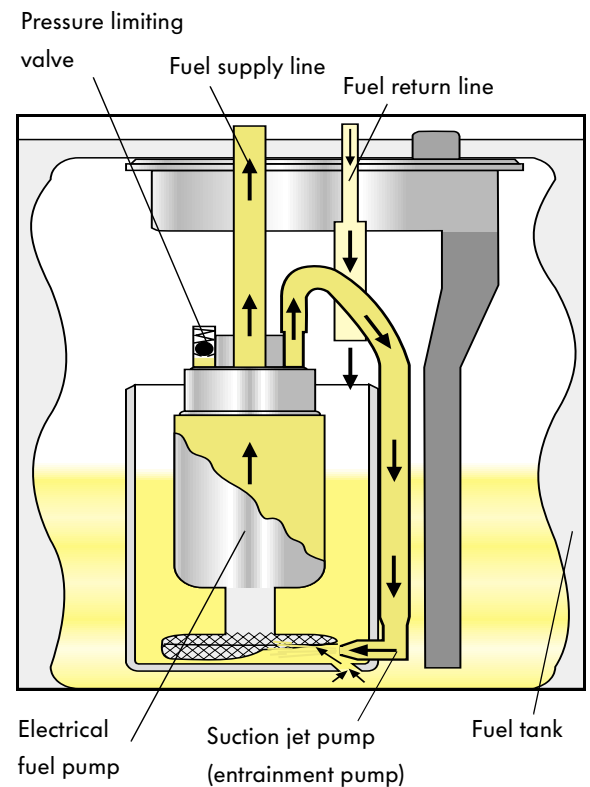

223_206

The fuel cooling system

The high pressure in the unit injectors causes the fuel to heat up to such a high degree that it has to be cooled before it flows back into the fuel tank.

For this purpose, a fuel cooler is located below the vehicle underbody. It has several parallel

ducts through which the returning fuel flows in a loop.

The fuel is cooled by ambient air flowing along the cooler, protecting the fuel tank and the fuel level sender against exposure to excessively high fuel temperatures.

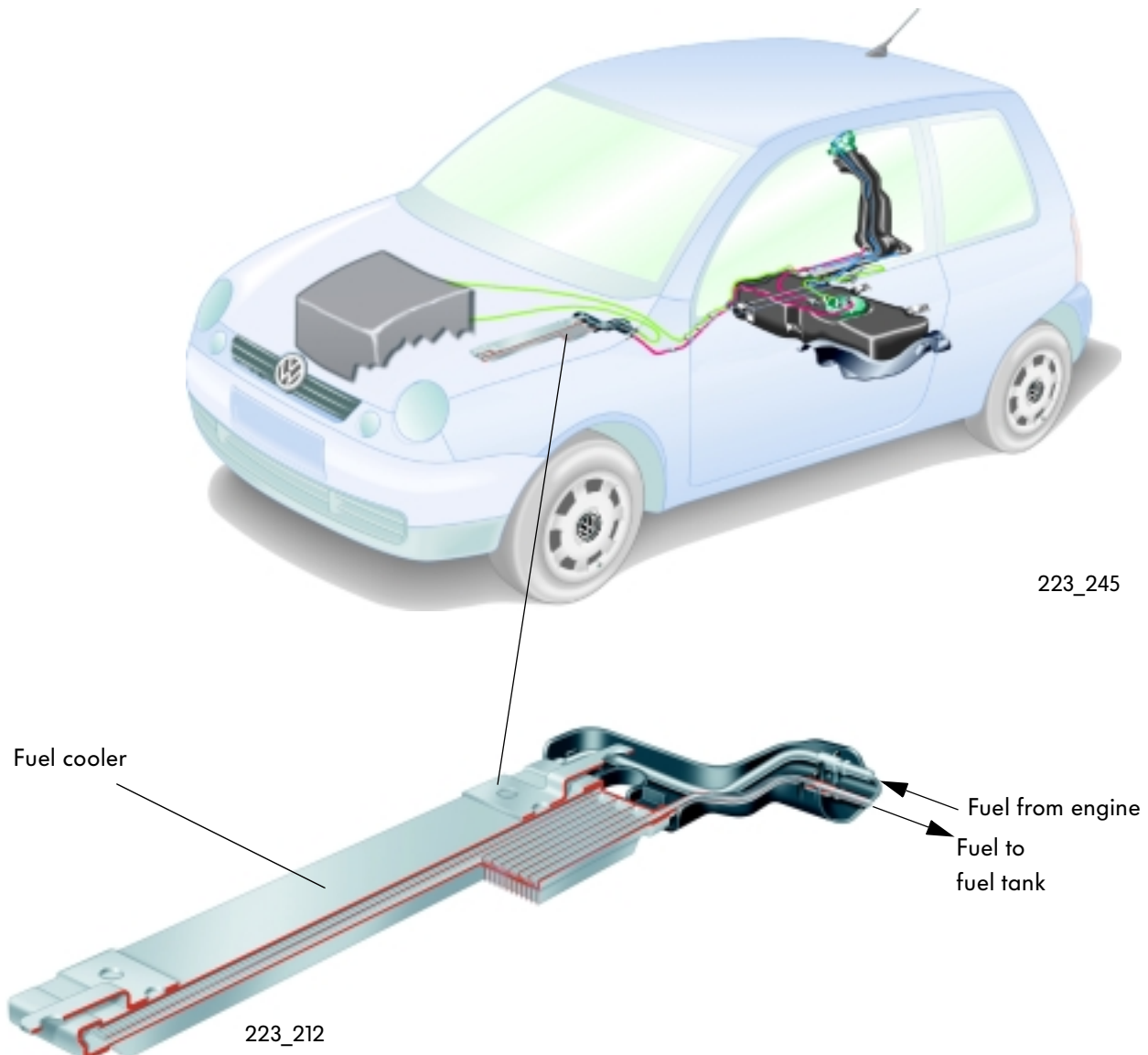
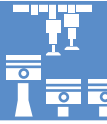

Exhaust system

The exhaust systems of the 1.2l TDI and 1.4l TDI engines differ mainly in respect of their weight, as well as number and layout of the catalytic converters and silencers.

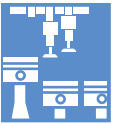

Exhaust system of the 1.2l engine

The exhaust system of the 1.2l TDI engine comprises a primary catalytic converter, a main catalytic converter and a main silencer. The primary catalytic converter is the smaller of the two and is positioned near to engine. As a result, the catalytic converter reaches its

operating temperature early. Only a small silencer is required on account of the engine's small displacement. For weight reduction reasons, the wall thicknesses of the exhaust pipes are reduced.

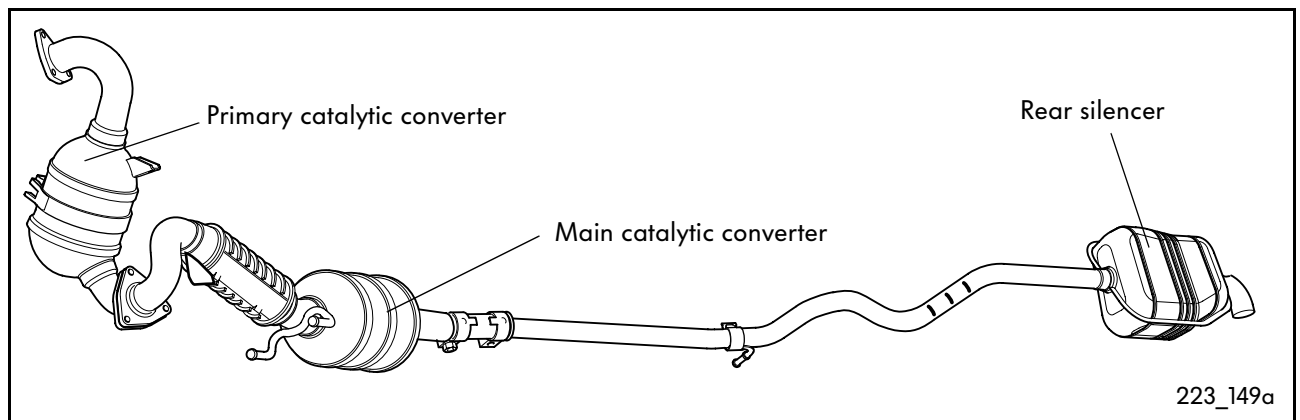

Exhaust system of the 1.4l engine

The exhaust system of the 1.4l TDI engine is of conventional design. It comprises a catalytic converter, a middle silencer and a rear silencer.

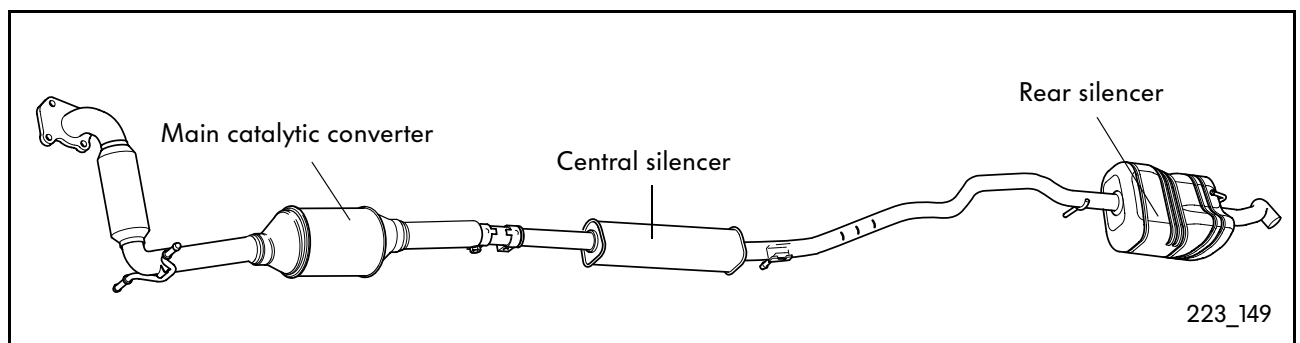

The EGR cooler

The 1.2l TDI engine has a cooler for exhaust gas recirculation. This cooler is located between the intake manifold flap housing and the exhaust manifold. Cooling the recirculated exhaust gases reduces the combustion temperature and nitrogen oxide emission.

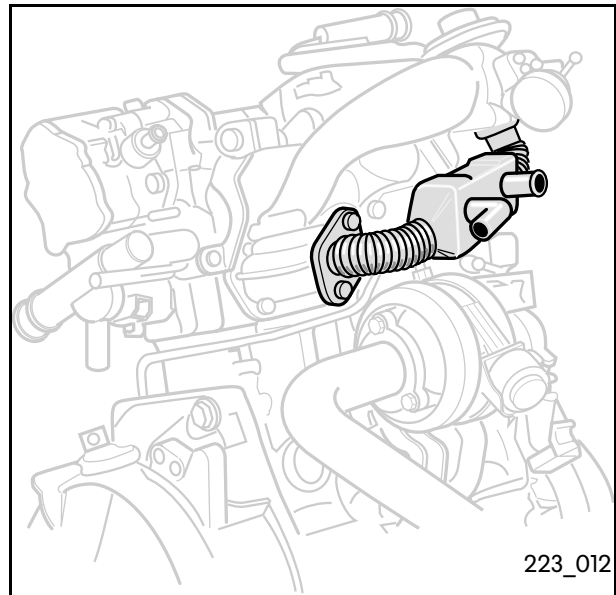

This is how it works:

The EGR cooler is connected to the coolant circuit. To enlarge the cooling surface, the metal body (heat sink) is channelled in a honeycomb-like pattern. Coolant flows through these channels. The recirculated exhaust gas flows past

the channels and dissipates the heat into the coolant.

The cooled exhaust gas reduces the combustion temperature still further and causes additional reduction of the nitrogen oxides.

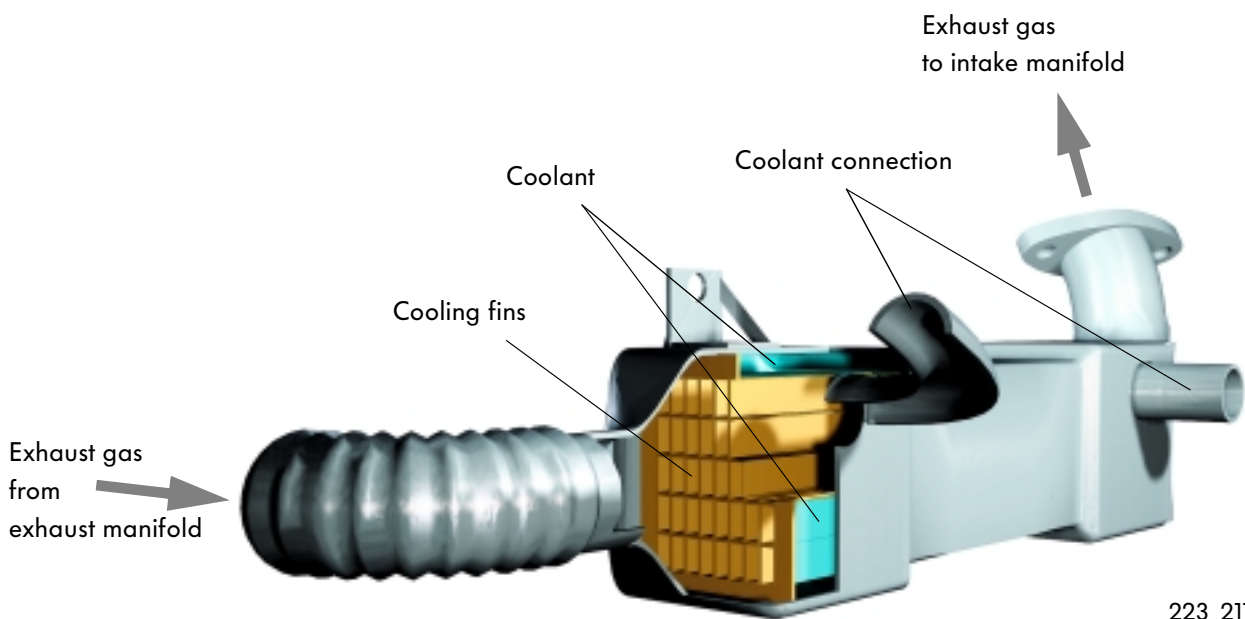

Engine management

System overview

Sensors

Hall sender G40



Engine speed sender G28

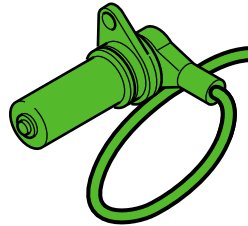

Accelerator for pedal position sender G79
Kick-down switch F8
Idling speed switch F60



Air-mass flow meter G70

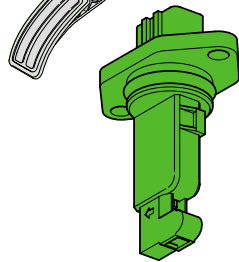

Coolant temperature sender G62



Clutch pedal switch F36*
(*1.4l TDI only)

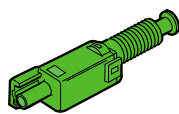

Intake manifold pressure sender G71
Intake manifold temperature sensor G72

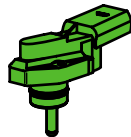

Brake light switch F
and brake pedal switch F47

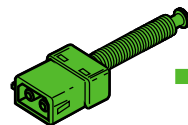

Fuel temperature sender G81

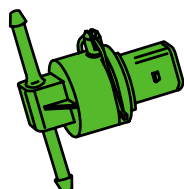

Altitude sender F96

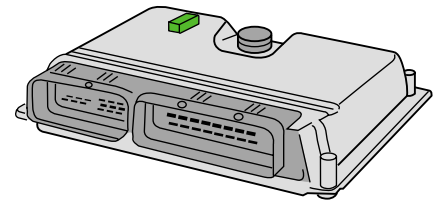

Self diagnosis lead and immobiliser lead

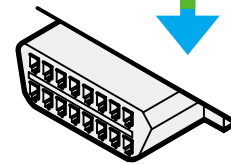

ABS control unit J104

Control unit with display unit in dash panel insert J285



Actuators

Diesel direct injection system control unit J248

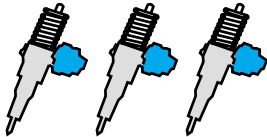

Unit injector valves, cylinder 1-3 N240-N242

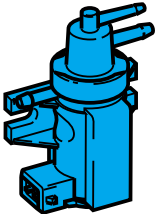

Charge pressure control solenoid valve N75

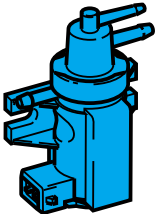

EGR valve N18



Intake manifold flap change-over valve N239

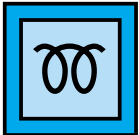

Glow period warning lamp K29

Glow plug relay J52

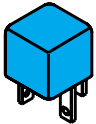

Glow plugs Q6

Low heat output relay J359

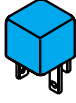

High heat output relay J360

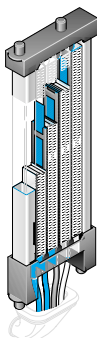

Additional heating heater element Z35

223_008

CAN databus

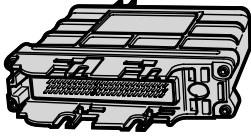

Electronic manual gearbox control unit J514



Engine management system

Sensors

Hall sender G40

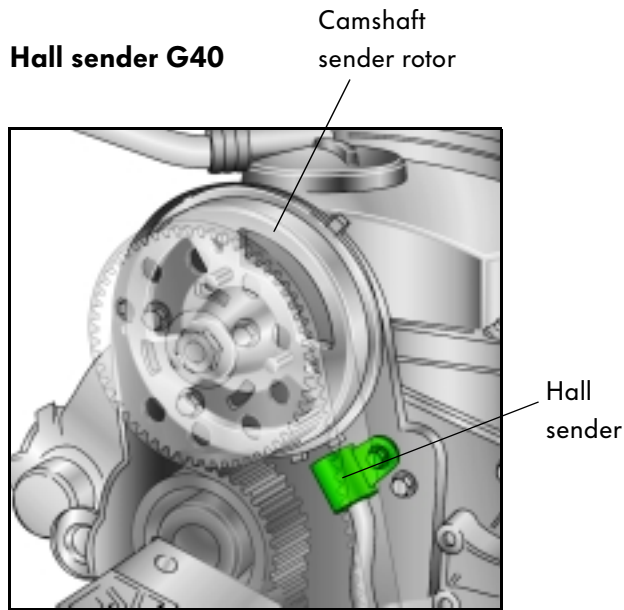

The Hall sender is attached to the toothed belt guard below the camshaft gear wheel. It scans seven teeth on the camshaft sender wheel, which is attached to the camshaft gear wheel.

223_246

Signal utilisation



The engine control unit uses the signal from the Hall sender for cylinder recognition when starting the engine.

Effects of signal failure

If the signal fails, the control unit utilises the signal from engine speed sender G28.

Electrical circuit

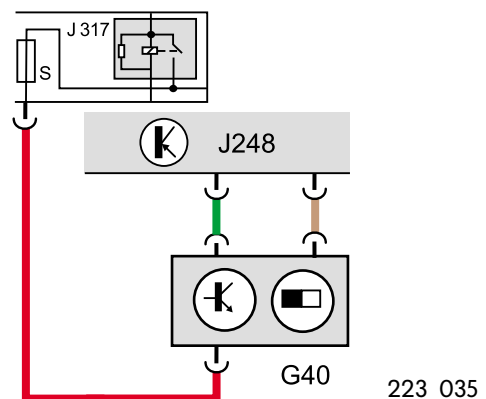

Cylinder recognition when starting the engine

When the engine is started, the engine control unit needs to know what cylinder is in the compression stroke in order to activate the corresponding injector solenoid valve. To obtain this information, the engine control unit evaluates the signal from the Hall sender. The Hall sender scans the teeth on the camshaft sender wheel and thus determines the position of the camshaft.

The camshaft sender wheel

As the camshaft performs one 360° revolution per working cycle, there is one tooth for each cylinder on the sender rotor. The interval between teeth is 120°.

To be able to assign the teeth to the cylinder, the sender rotor has an additional tooth for cylinder 1 and 2. These teeth are different distances apart.

This is how it works:

Each time a tooth passes the Hall sender, this generates a Hall voltage, which is transmitted to the engine control unit. From the different intervals between the signals,

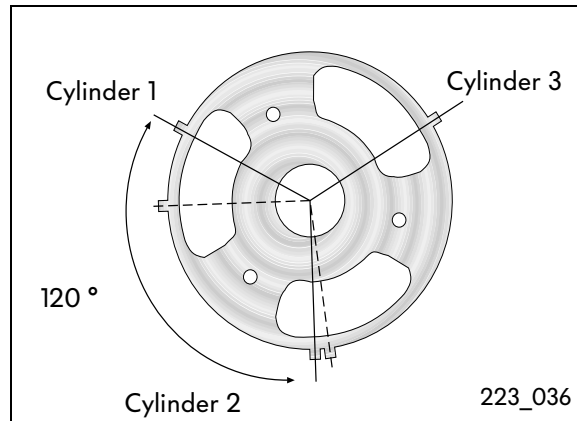

the engine control unit recognises the cylinder, and hence can activate the corresponding injector solenoid valve.

Signal pattern, Hall sender

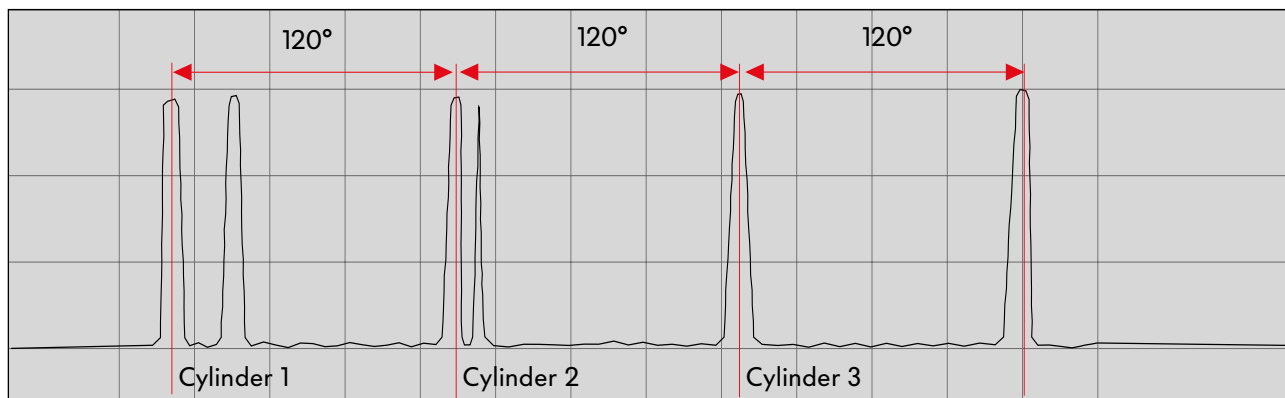

Engine management

The engine speed sender G28

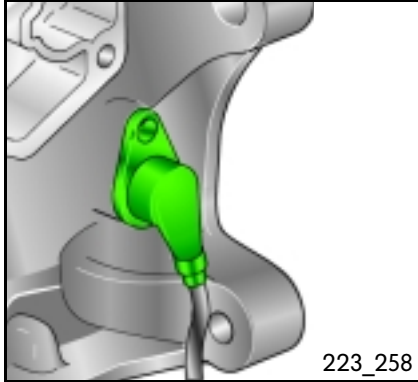

The engine speed sender is an inductive sender. It is attached to the cylinder block.

Engine speed sender wheel

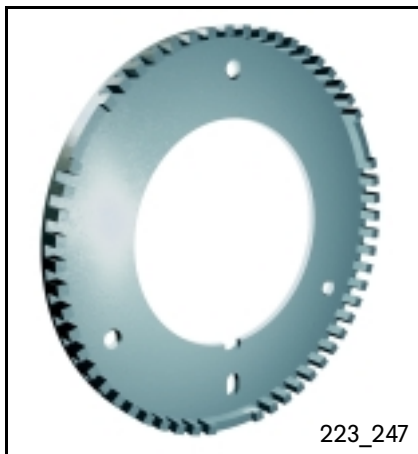

The engine speed sender scans a 60-2-2-2 sender rotor which is attached to the crankshaft. The sender rotor has 54 teeth around its circumference and 3 gaps of 2 teeth. The gaps are offset by 120° and serve as reference marks for determining the crankshaft position.

Signal utilisation

The engine speed and the exact position the crankshaft are determined using the signal from the engine speed sender. The injection point and the injection quantity are computed on the basis of this information.

Effects of signal failure

If the signal from the engine speed sender fails, the engine is shut off. It is not possible to restart the engine.

Electrical circuit

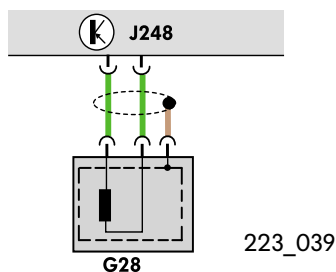

Function the quick start recognition feature To facilitate a quick start, the engine control unit evaluates the signals from the Hall sender and the engine speed sender.

The engine control unit recognises the cylinder from the signal from the Hall sender which the camshaft sender wheel scans. As there are 3 gaps on the crankshaft sender rotor, the engine control unit receives a reference signal after every one third crankshaft rotation. The engine control unit can thus recognise early the position of the crankshaft and activate the corresponding solenoid valve in order to initiate the injection cycle.



Signal pattern, Hall sender / engine speed sender

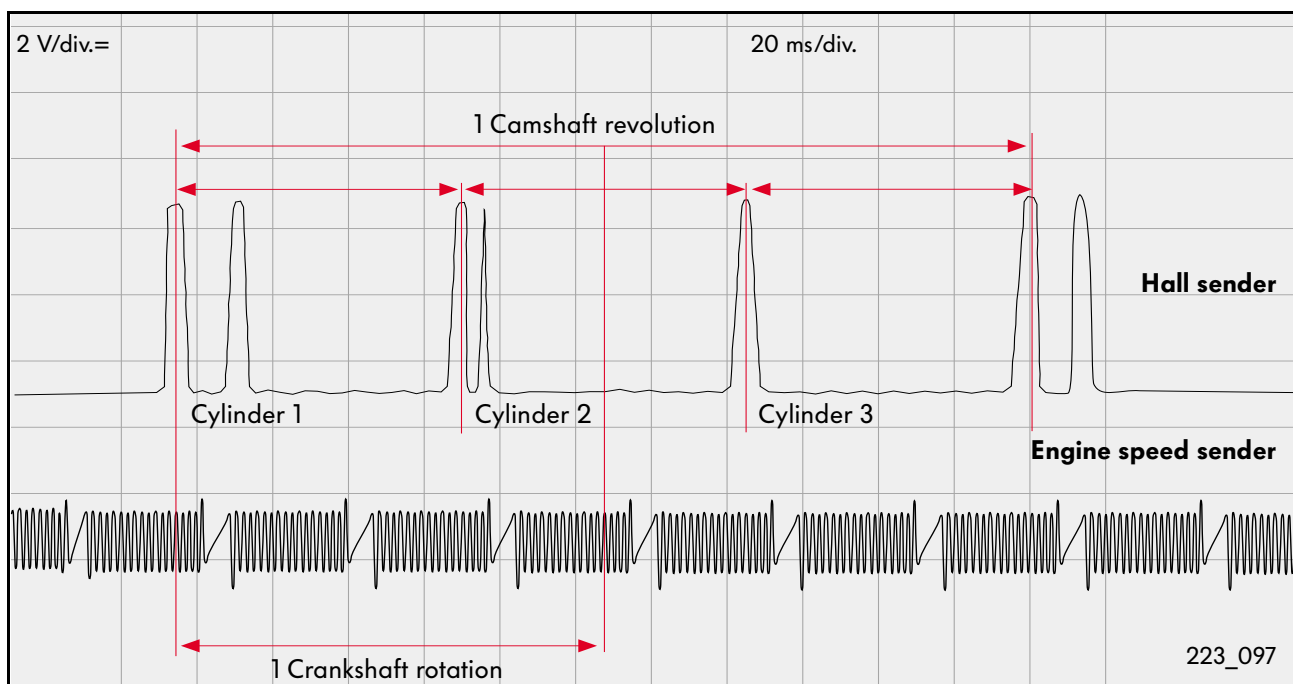

Engine management system

Accelerator position sender

The accelerator position sender has been developed into a compact accelerator pedal module. On the new accelerator pedal module, the potentiometers are actuated directly and not via a cable pull. As a result, it is no longer necessary to adjust the accelerator pedal position sender after installation. The exterior mechanical construction of the sender is identical to that of the accelerator pedal module of the electrical throttle control used in petrol engines.

The following components are integrated in the accelerator pedal module:

- accelerator position sender G79,
- idling speed switch F60 and
- kick-down switch F8.

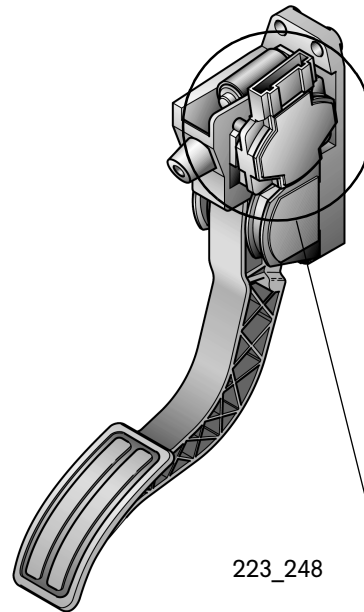

223_248

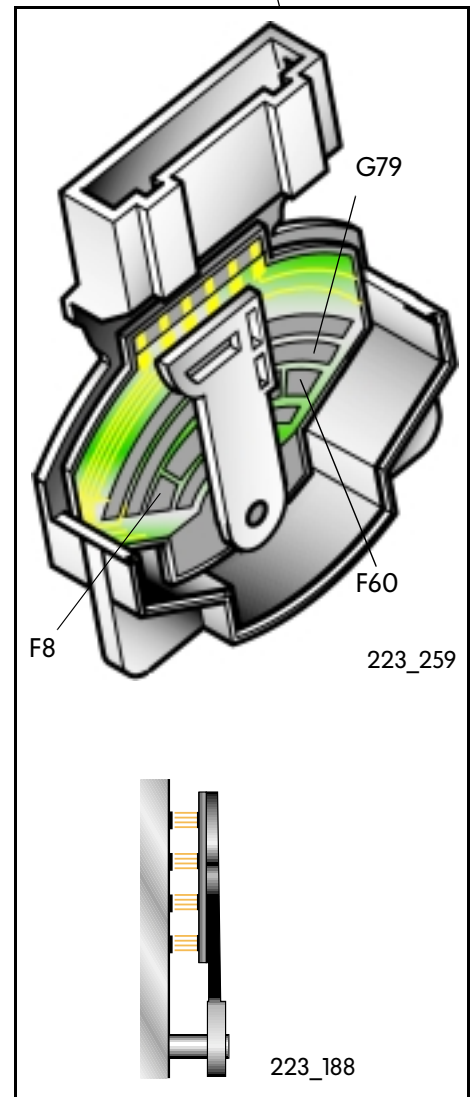

G79

F60

F8

223_259



223_188

The sensors comprise sliding contact paths and slip contacts. The slip contacts are mounted together on a shaft.

Signal utilisation

Accelerator position sender G79

is a sliding contact potentiometer. After every change in accelerator pedal position, the resistance changes. From this, the engine control unit recognises the actual accelerator pedal position and uses the information as a main influencing variable for computing the injection quantity.

Idling speed switch F60 and kick-down switch F8 are sliding contact switches. When the switch is open, the sliding contact paths are interrupted and the resistance is infinite. If the switch is closed, the resistance along the sliding contact paths is constant.

Idling speed switch F60 indicates to the engine control unit that the accelerator pedal is not depressed.

Kick-down switch F8 informs the engine control unit when the accelerator pedal is depressed past the full-throttle stop. In the Lupo 3L with electronic manual gearbox DS085, this signal is utilised for the kick-down function.



Effects of signal failure

Without this signal, the engine control unit cannot determine the accelerator pedal position. The engine continues to run at an increased idling speed to enable the driver to reach the next workshop.

Electrical circuit

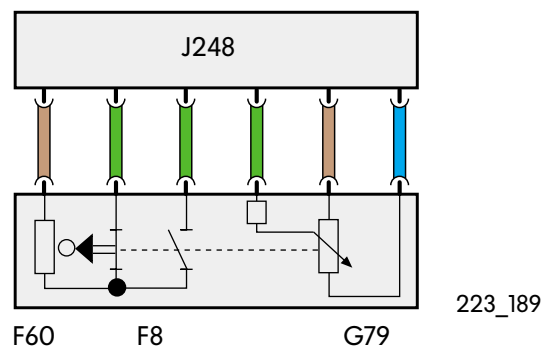

Engine management system

The following sensors were previously described in other Self-Study Programmes on TDI engines. For this reason, they are explained here in less detail than in the previous SSPs.

Air-mass flow meter G70

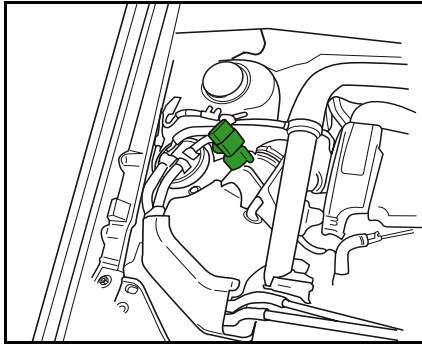

223_151

The air-mass flow meter with reverse flow recognition determines the intake air mass. It is located in the intake pipe. The opening and closing movements of the valves cause the air mass drawn into the intake pipe to flow backwards. The air-mass flow meter with reverse flow recognition recognises the returning air mass and makes allowance for this in the signal it sends to the engine control unit. As a result, the air mass measurement is highly precise.

Signal utilisation

The engine control unit uses the measured values to calculate the injection quantity and the exhaust gas recirculation rate.

Effects of signal failure

If signal the from the air-mass flow meter fails, the engine control unit uses a fixed default value.

Coolant temperature sender G62

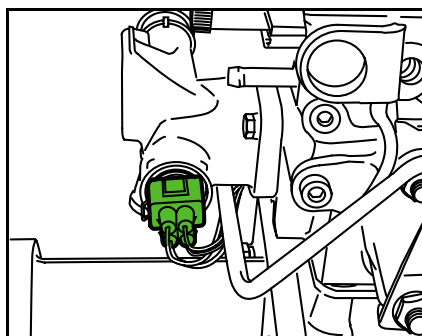

223_041

The coolant temperature sender is located on the coolant connection of the cylinder head. It informs the engine control unit about the actual coolant temperature.

Signal utilisation

The engine control unit uses the coolant temperature as a compensating value for computing the injection quantity.

Effects of signal failure

If the signal fails, the engine control unit uses the signal from the fuel temperature sender as a default value.

Intake manifold pressure sender G71 Intake manifold temperature sender G72

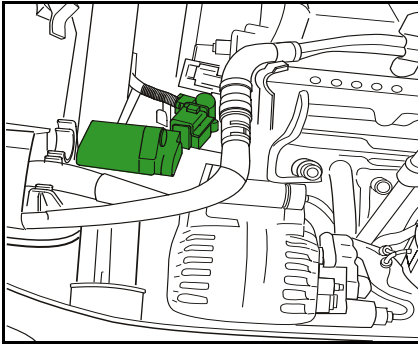

223_043

The intake manifold pressure sender and the intake manifold temperature sensor are combined as a unit located in the intake pipe.

Intake manifold pressure sender G71 - Signal utilisation

The signal from the intake manifold pressure sender is required to check the charge pressure. The engine control unit compares the calculated value with the set value from the charge pressure map. If the actual value deviates from the set value, then the engine control unit adjusts the charge pressure via the charge pressure control solenoid valve.



Effects of signal failure

It is no longer possible to control the charge pressure.
The engine has less power.

Intake manifold temperature sensor G72 - Signal utilisation

The engine control unit requires the signal from the intake pipe temperature sender as a compensating value for computing the charge pressure. Thus, allowances are made for the effect of temperature on the density of the charge air.

Effects of signal failure

If the signal fails, the engine control unit uses a fixed default value. This can result in a loss of performance.

Engine management system

The altitude sender F96

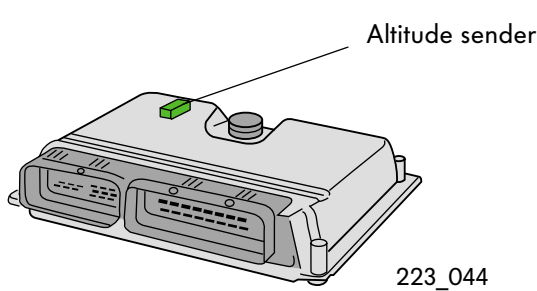

The altitude sender is located in the engine control unit.

Signal utilisation

The altitude sender indicates the actual ambient air pressure to the engine control unit. This value is dependent on the vehicle's geographical altitude. With this signal, the engine control unit makes an altitude-based correction for charge pressure control and exhaust gas recirculation.

Effects of signal failure

Black smoke occurs at high altitudes.



Clutch pedal switch F36

(on 1.4l TDI engine only)

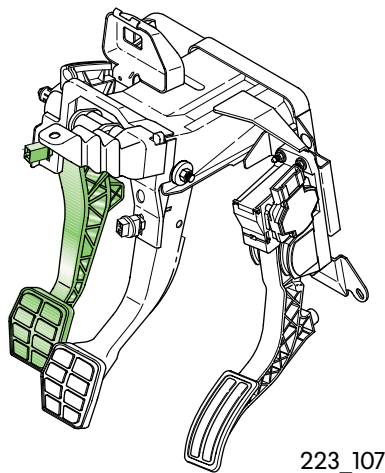

The clutch pedal switch is located on the pedal assembly.

Signal utilisation

From this signal, the engine control unit recognises whether the clutch is engaged or disengaged. When the clutch pedal is depressed, the injection quantity is reduced for a short time. This prevents engine shudder when changing gear.

Effects of signal failure

If the signal from the clutch pedal switch fails, then load change jolts can occur during gearchanges.

Brake light switch F and brake pedal switch F47

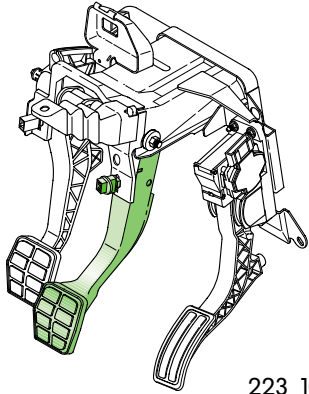

223_106

The brake light switch and the brake pedal switch are combined as a unit located on the pedal assembly.

Signal utilisation

Both switches supply the engine control unit with the "brake operated" signal. As the accelerator position sender could be defective, engine speed is limited for safety reasons when the brake is depressed.

Effects of signal failure

If one of the two switches fails, the engine control unit reduces the fuel quantity. This results in loss of engine power.



Fuel temperature sender G81

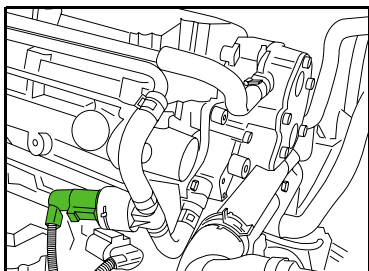

223_093

The fuel temperature sender is a temperature sensor with a negative temperature coefficient (NTC). This means that the resistance of the sensor decreases with increasing fuel temperature. The fuel temperature sensor is located in the fuel return line from the fuel pump to the fuel cooler and determines the actual fuel temperature.

Signal utilisation

To allow for the density of the fuel at different temperatures, the engine control unit requires the actual fuel temperature in order to compute the commencement of injection point and the injection quantity.

Engine management

CAN databus signals

The Lupo 3L is fitted with electronic manual gearbox DS085. This gearbox performs gearshifts automatically and thereby makes it possible to operate the vehicle in the most economical gear in any driving situation. The gearbox control unit and the engine control unit exchange a large volume of information across the CAN databus. The gearbox control unit uses this information to calculate gear shifts: the engine control unit to control engine torque output.

The following examples clearly show how data is transferred between the engine control unit and gearbox control unit.

- The gearbox control unit uses the information supplied by the engine control unit - such as engine speed, engine torque, engine load and accelerator pedal position - to compute the gear selection.
- The gearbox control unit informs the engine control unit about gear changes in order to prevent the engine revving-up when the clutch is open.
- If the engine is to be shut off using the STOP/START function, the gearbox control unit sends the message "engine off". The engine control unit now disconnects the power supply to the unit injector valves.

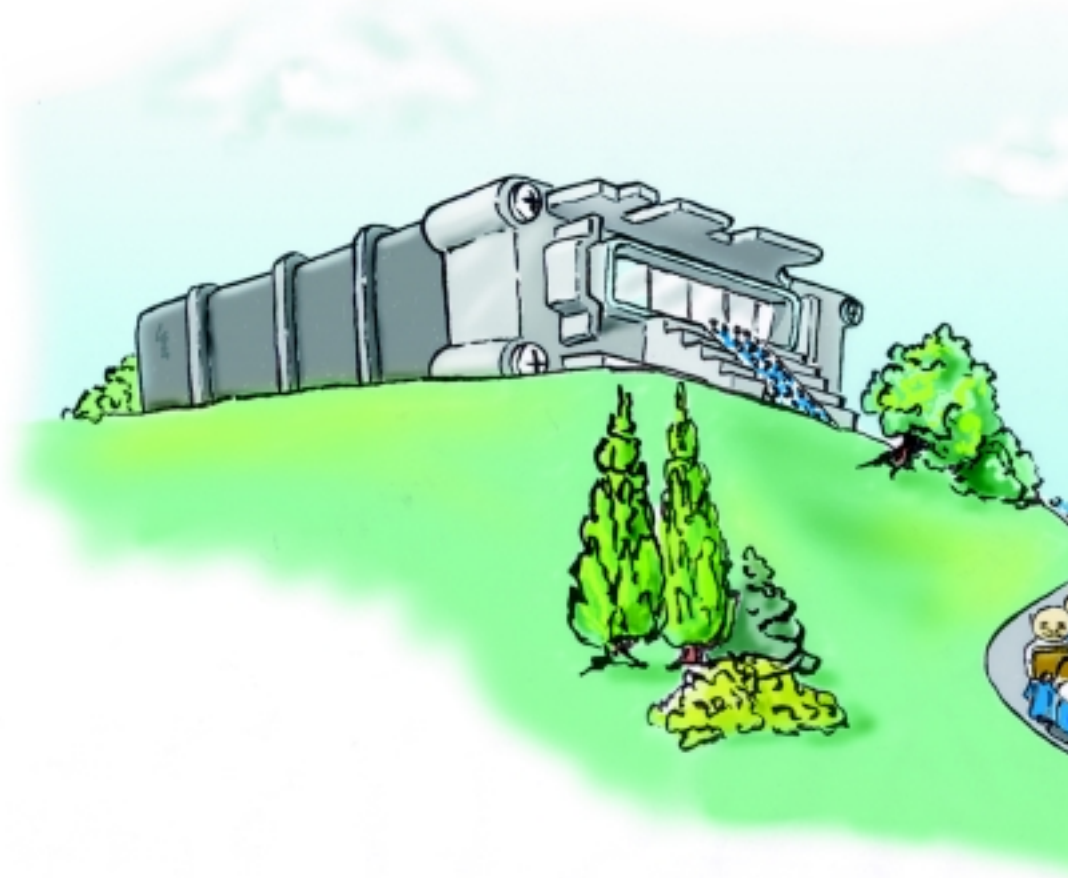

223_284

Data are also transferred across the CAN databus between the engine control unit, the control unit in the dash panel insert and the ABS control unit.

- The engine control unit transfers the engine speed for the rev counter and the consumption signal for the fuel consumption display to the control unit in the dash panel insert.
- For engine braking control (EBC), the ABS control unit sends a command to increase engine speed to the control unit. This prevents the driven wheels locking on slippery road surfaces if the driver quickly releases the accelerator pedal.

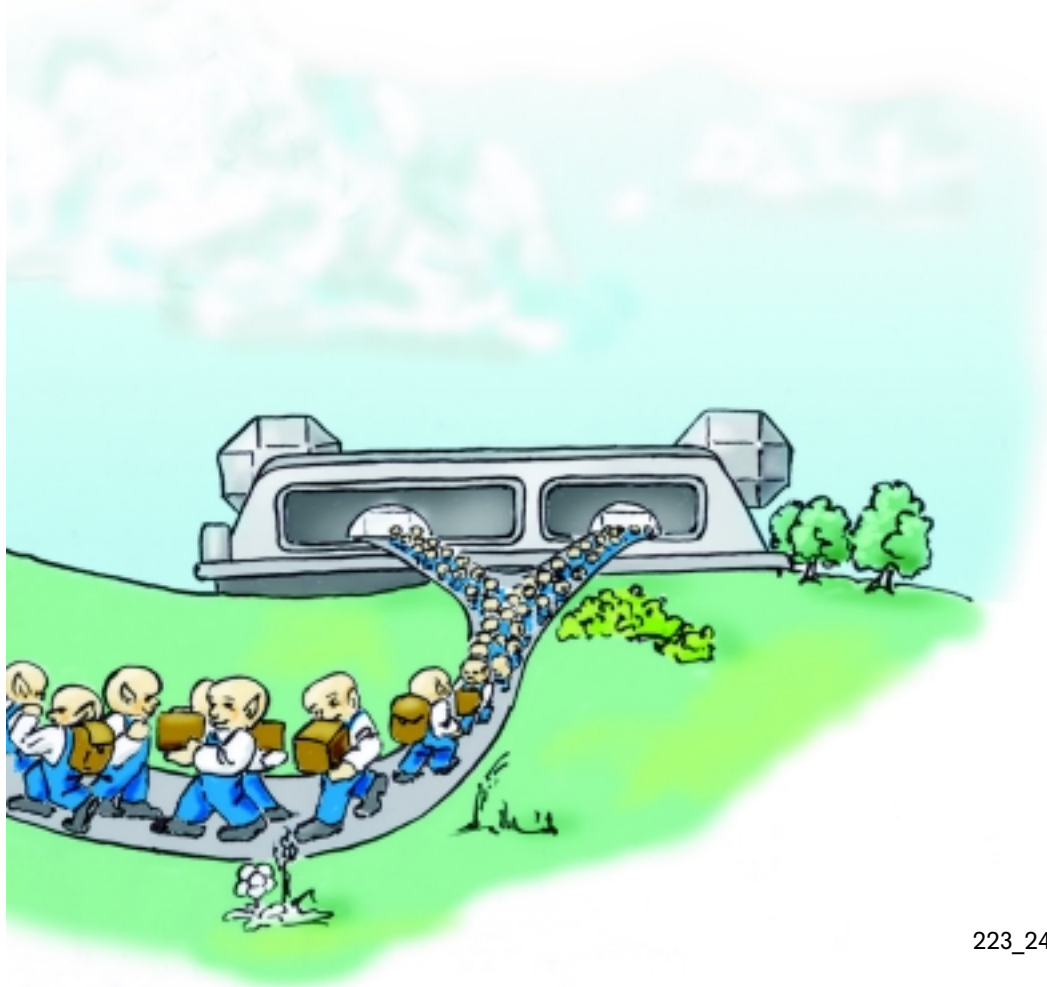

Engine management system

Actuators:

Unit injector valves N240-N242.

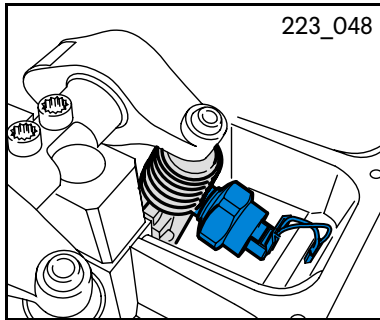

Commencement of injection point

The unit injector valves are attached to the unit injectors with a cap nut. They are solenoid valves which are activated by the engine control unit. The commencement of injection point and the injection quantity are regulated by the engine control unit via the unit injector valves.

As soon as the engine control unit activates an injector solenoid valve, the solenoid valve stem is pressed into the seat by the magnetic coil and shuts off the path from the fuel supply to the high-pressure chamber of the unit injector. The injection cycle then commences.



Injection quantity

The injection quantity is defined by the solenoid valve's activation period. Fuel is injected into the combustion chamber as long as the injector solenoid valve is closed.

Effects of failure

If an injector solenoid valve fails, the engine will run rough and have less power. The injector solenoid valve has two safety functions. If the valve stays open, pressure cannot be built up in the unit injector. If the valve stays closed, the high-pressure chamber of the unit injector can no longer be filled. In both cases, no fuel is injected into the cylinder.

Electrical circuit

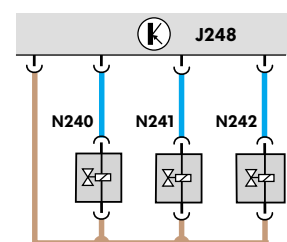

223_049

The following actuators were previously described in other Self-Study Programmes on TDI engines. For this reason, they are explained here in less detail than in the previous SSPs.

Solenoid valve for charge pressure control N75

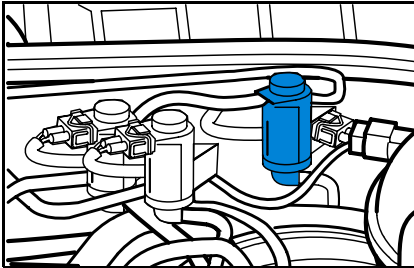

223_155

The charge pressure control solenoid valve is an electro-pneumatic valve. It switches the control pressure to actuate the vacuum box for vane adjustment (1.2l TDI engine) or the charge pressure control valve (1.4l TDI engine).

Charge pressure control of the 1.2l TDI engine

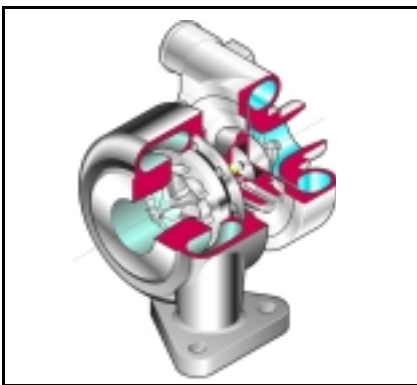

223_250

The 1.2l TDI engine has a variable turbine geometry. The exhaust gas flow onto the turbine rotor is controlled by the adjustable guide vanes. This ensures quick response at low engine speeds. The back pressure in the exhaust is reduced in the part-throttle range. The result is high bottom-end torque and low fuel consumption.

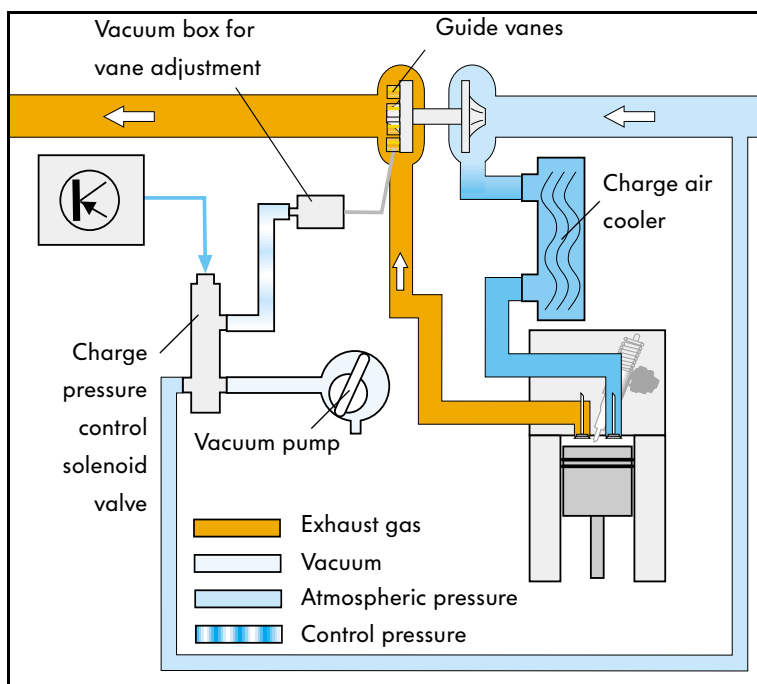

223_200

The charge pressure is controlled according to a map stored in the engine control unit. For this purpose, the charge pressure control solenoid valve is activated by the engine control unit. The control pressure used to actuate the vacuum box for vane adjustment is defined in dependence on the signal's pulse duty factor. The exhaust gas flow onto the turbine rotor is controlled by the guide vanes. The control pressure is produced from atmospheric pressure and vacuum.

Engine management system

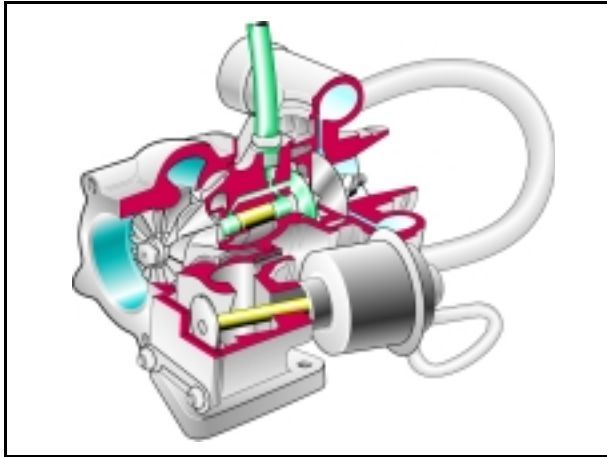

223_251

The 1.4l TDI engine achieves its high torque with a non-variable turbine geometry.

Charge pressure control in the 1.4l TDI engine

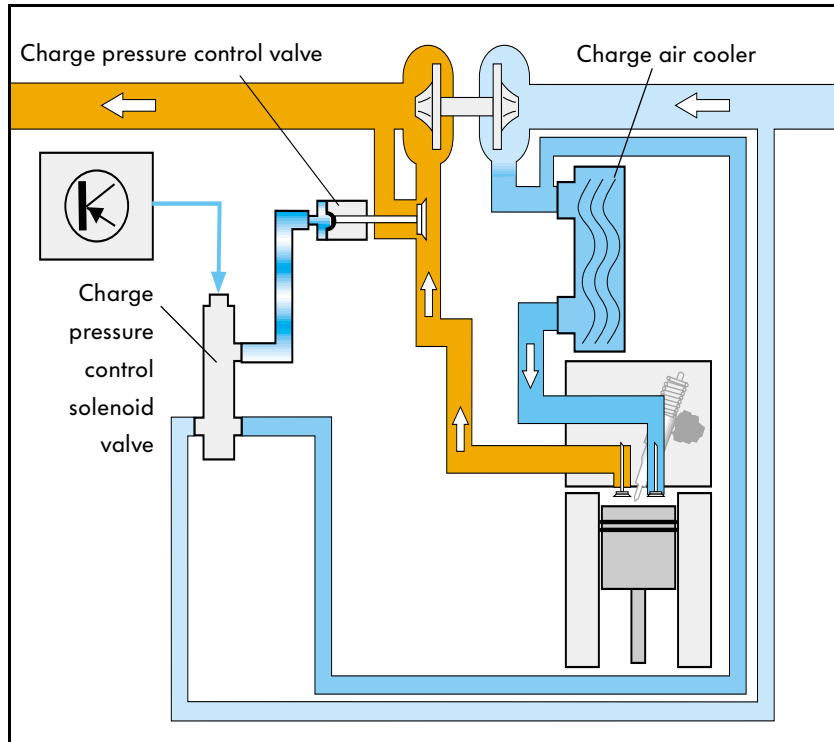

223_199

The charge pressure control solenoid valve is activated by the engine control unit. The control pressure used to actuate the charge pressure control valve is defined in dependence on the signal's pulse duty factor. The flow rate of

the exhaust gas ducted to the turbine rotor to drive the turbocharger is thus controlled. On the 1.4l TDI engine, the control pressure is produced from atmospheric pressure and charge pressure.

Effects of failure

If the charge pressure control solenoid valve fails, engine performance will be reduced.

Exhaust gas recirculation valve N18

The EGR valve is an electro-pneumatic valve. It is located in the engine compartment on the engine bulkhead and switches the control pressure used to actuate the EGR valve.

Exhaust gas recirculation is a way of reducing nitrogen oxides in the exhaust gas. A portion of the exhaust gases is added to the intake air. The oxygen level in the combustion chamber and the combustion temperature are thus reduced. The lower combustion temperature reduces nitrogen oxide emission. When the vehicle is operating at full throttle, no exhaust gas is

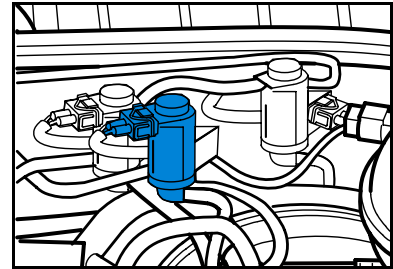

223_157

recirculated because a high oxygen level is required for effective power utilisation in the combustion chamber.

This is how it works:

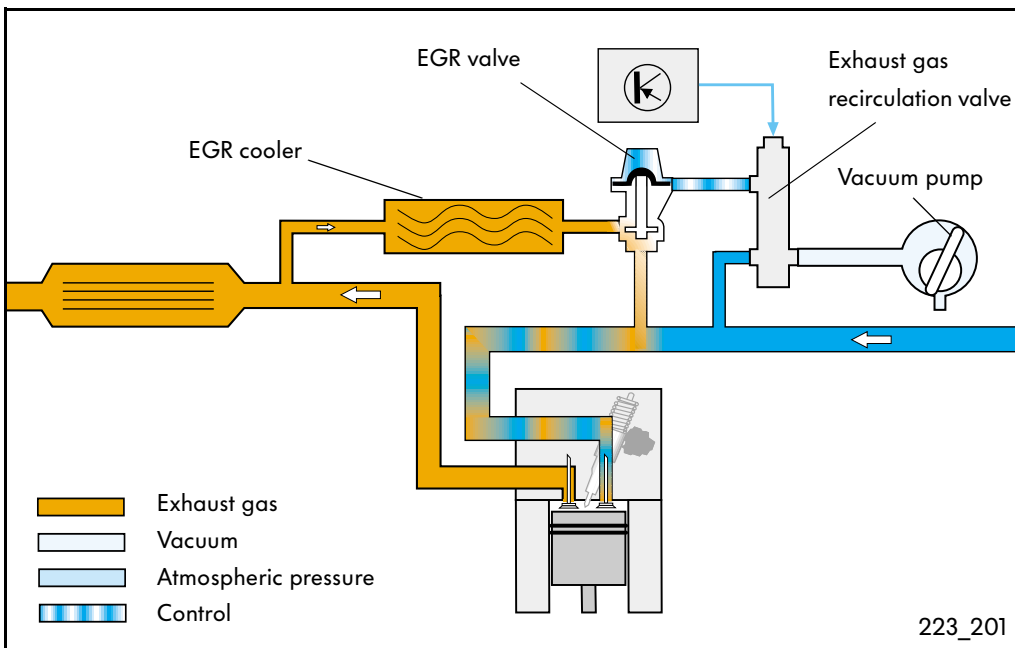

Exhaust gas recirculation is controlled by a map stored in the engine control unit. For this purpose, the engine control unit activates the EGR valve. The control pressure used to actuate the EGR valve is defined in dependence on the signal's pulse duty factor. The quantity of recirculated exhaust gases is thus regulated.

Effects of failure

Exhaust gas recirculation is not assured.



Engine management system

Intake manifold flap change-over valve N239

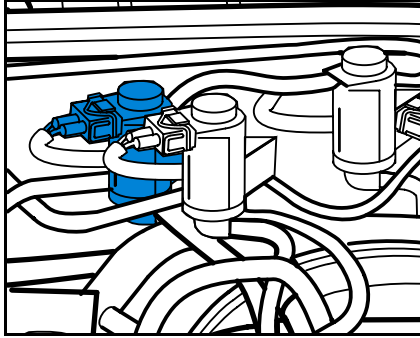

223_052

The intake manifold flap change-over valve is located in the engine compartment in the vicinity of the air-mass flow meter. It switches the vacuum for actuating the intake manifold flap in the intake pipe. It prevents the engine from jolting at shut-off. Diesel engines have a high compression ratio. The high compression pressure of the induced air acts on the crankshaft via the piston and conrod and causes the engine to jolt at shut-off.

The intake manifold flap disconnects the air supply when the engine is turned off. As a result, only a small amount of air is compressed and the engine smoothly runs to a halt.

This is how it works:

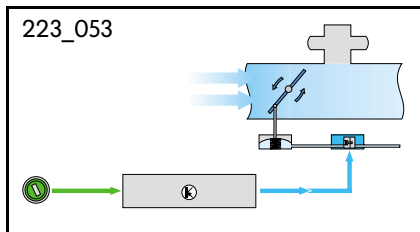

If the engine is turned off, the engine control unit sends a signal to the intake manifold flap change-over valve. The change-over valve then switches the vacuum for the vacuum box. The vacuum box closes the intake manifold flap.

Effects of failure

If the intake manifold flap change-over valve fails, the intake manifold flap remains open.

Electrical circuit

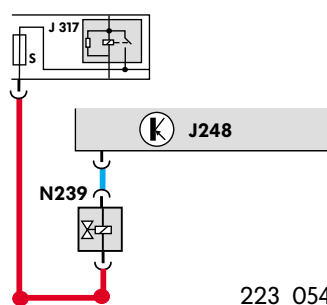

223_054

Glow period warning lamp K29



223_252

The glow period warning lamp is located in the dash panel insert.

It has the following tasks:

- It indicates to the driver that the glow plug system is active prior to starting the engine. The warning lamp is lit during the glow period.
- If there is a fault in a component with self-diagnostic capability, the warning lamp flashes.

Effects of failure

The warning lamp is lit and does not flash. A fault message is stored in the fault memory.



Engine management

Function diagram

30
15

Components



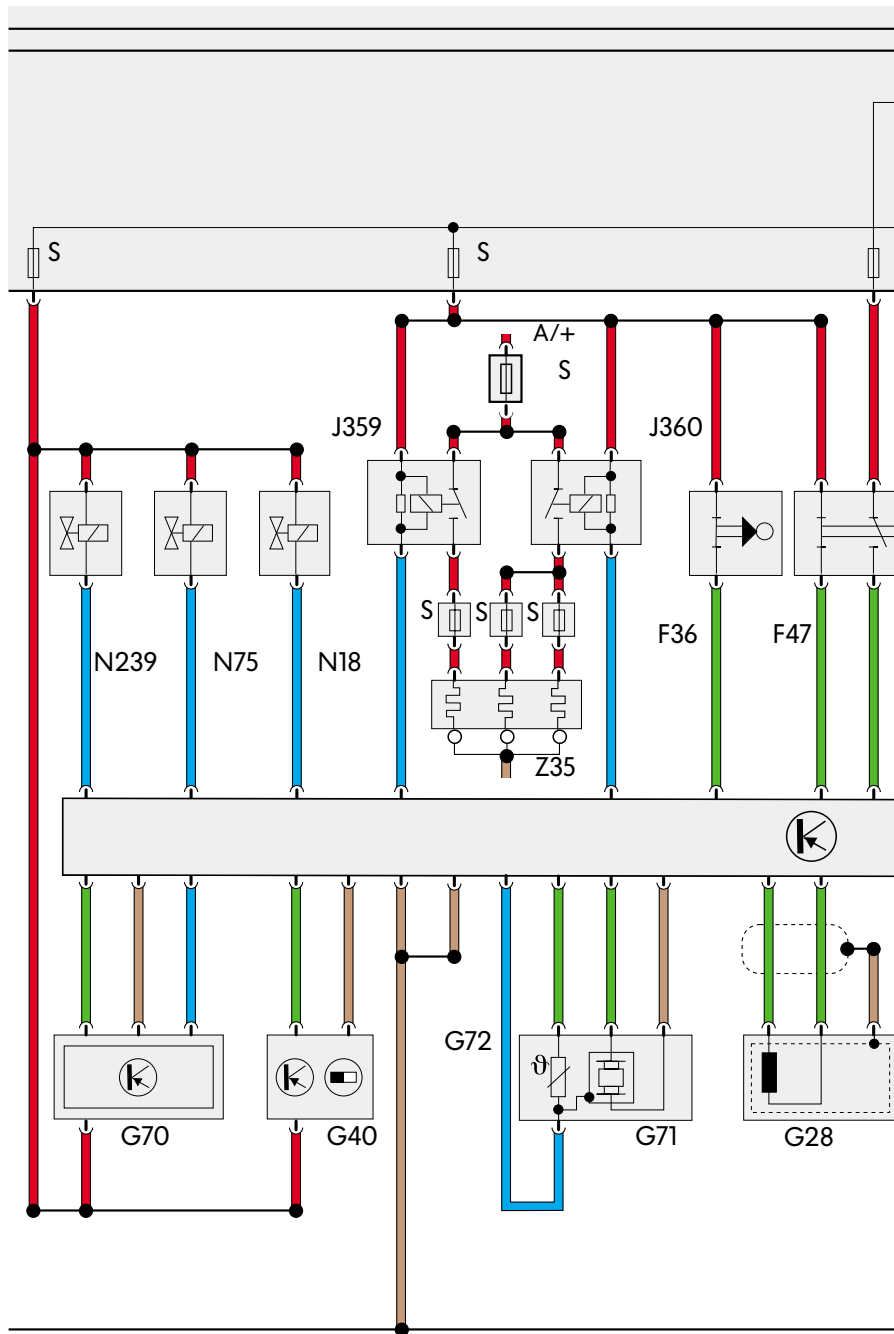

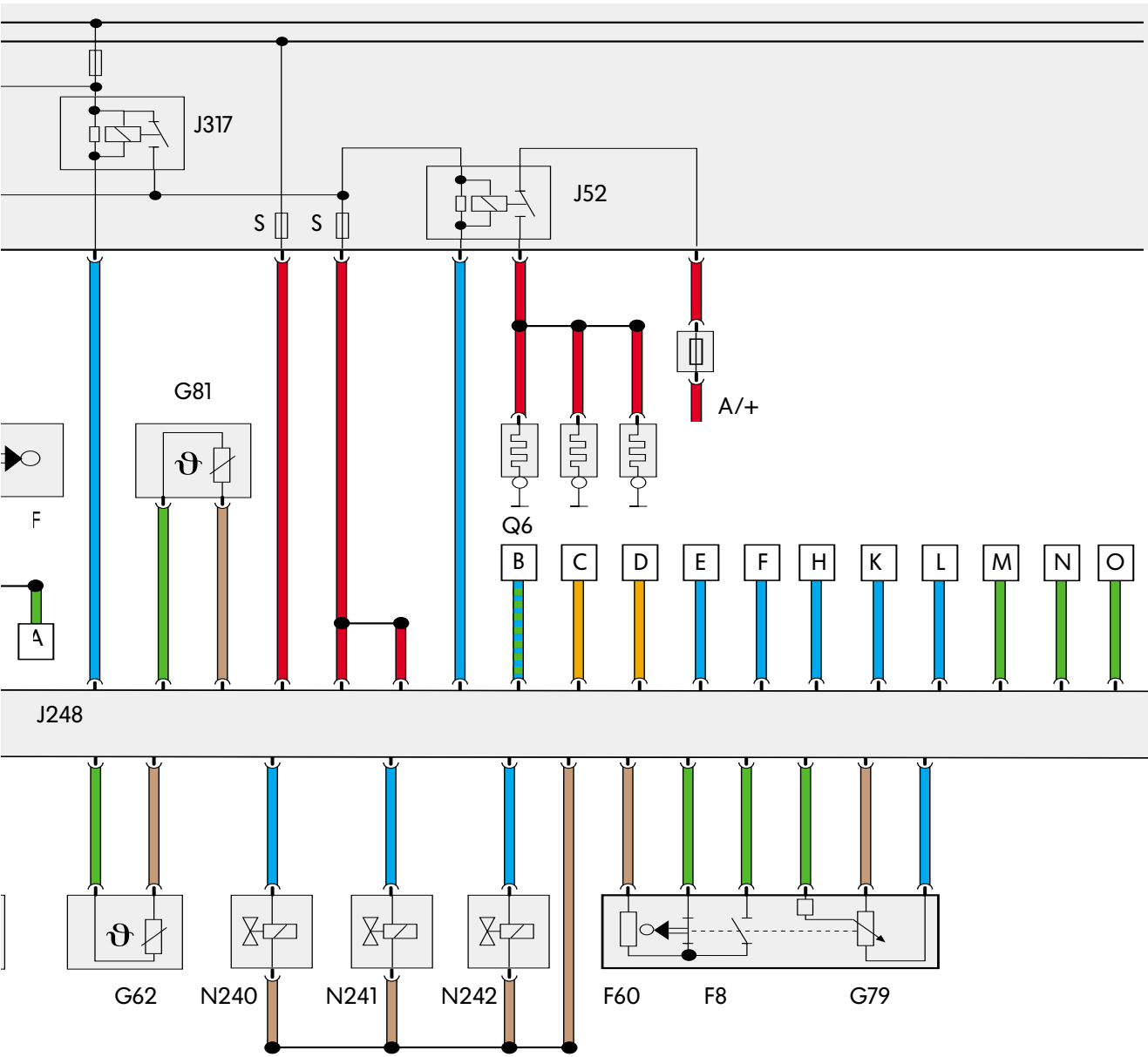
- F** Brake light switch
- F8** Kick-down switch
- F36** Clutch switch (*1.4l TDI only)
- F47** Brake pedal switch
- F60** Idling speed switch
- G28** Engine speed sender
- G40** Hall sender
- G62** Coolant temperature sender
- G70** Air-mass flow meter
- G71** Intake manifold pressure sender
- G72** Intake manifold temperature sender
- G79** Accelerator position sender
- G81** Fuel temperature sender
- J52** Glow plug relay
- J248** Diesel direct injection system control unit
- J317** Voltage supply relay
- J359** Low heat output relay
- J360** High heat output relay
- N18** EGR valve
- N75** Charge pressure control solenoid valve
- N239** Intake manifold flap change-over valve
- N240** No. 1 cylinder unit injector solenoid valve
- N241** No. 2 cylinder unit injector solenoid valve
- N242** No. 3 cylinder unit injector solenoid valve
- Q6** Glow plugs (engine)
- Z35** Additional heating element





209_006

Auxiliary signals

- | | |
|---|---|
| A Brake lights | L Glow period control |
| B Fuel consumption signal | M CAN-Bus-Low |
| C Engine speed signal | N CAN-Bus-High |
| D Air conditioner compressor cut-off | O Terminal DF |
| E Air conditioner compressor-readiness |  Input signal |
| F Road speed signal |  Output signal |
| H Cooling fan run-on |  Positive |
| K Diagnostic and immobiliser wire |  Earth |
| |  CAN databus |

Engine management

Glow plug system

The glow plug system makes it easier to start the engine at low ambient temperatures. The glow plug system is activated by the engine control unit at a coolant temperature of less than +9°C. The engine control unit activates the glow plug relay. This relay then switches on the working

current for the glow plugs. The system overview shows what sensors utilise signals for the glow plug system and what actuators are activated.

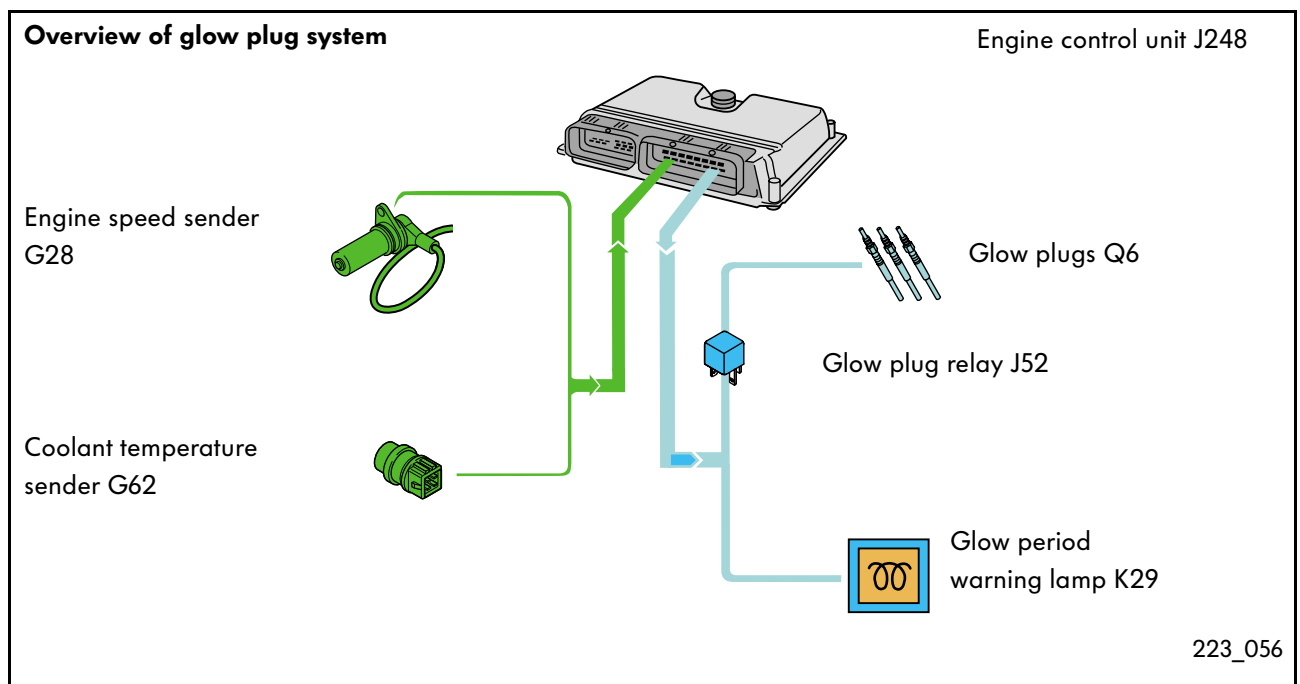

The glow cycle is subdivided into two phases.

Pre-heating phase

After the ignition is turned on, the glow plugs are activated at a temperature of below +9°C. The glow period warning lamp comes on. At the end of the glow cycle, the warning lamp goes out and the engine can be started.

Afterglow period

Engine start up is followed by an afterglow period, regardless whether pre-heating has taken place or not. This reduces combustion noise, improves idling quality and reduces hydrocarbon emission. The afterglow phase lasts no more than three minutes and is interrupted when the engine speed exceeds 2500 rpm.

The additional heater

On account of its high efficiency, the engines develop little waste heat. Available heating capacity may be too low.

In countries with a cold climate, therefore, an additional heating element is installed in the heater box.

This heating element is located in the air stream behind the heat exchanger.

The additional heating element comprises corrugated-fin type aluminium contact plates and fifteen ceramic PTC resistors subdivided into three heating elements. It heats the passing air flow and thus ensures that the passenger cabin heats up quickly.

PTC resistors are at their most conductive when they are cold. They have a positive temperature coefficient (PTC). This means, the resistance of the PTC thermistor increases with rising temperature, thus reducing the current flow.

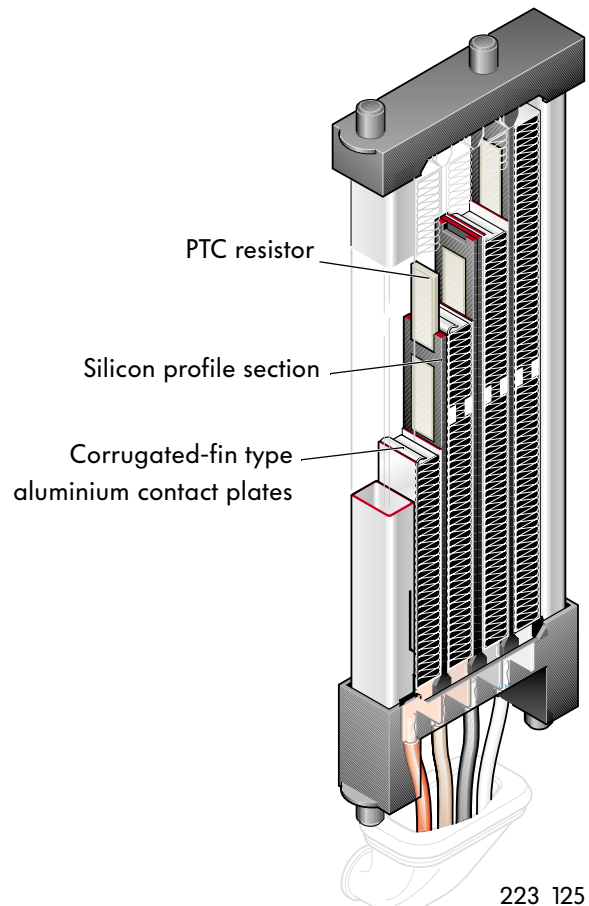
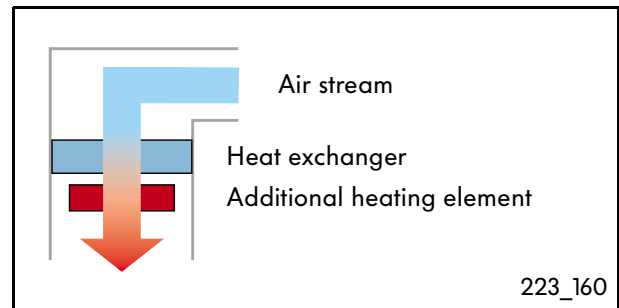
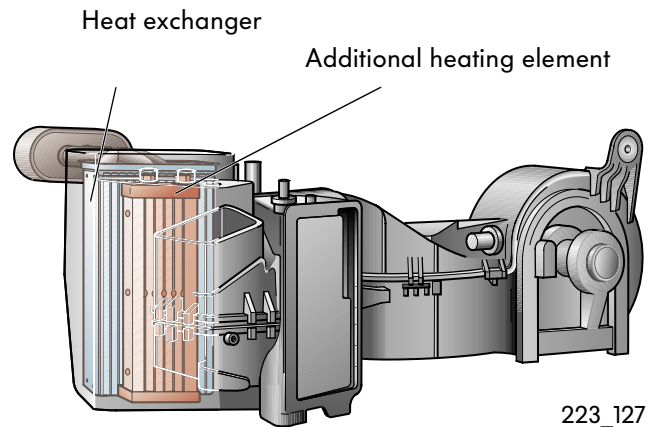

Engine management system

Heat output control

Approx. 10 seconds after the engine is started, the additional heating element of the diesel injection system control unit is activated.

The three heating elements are activated and deactivated in stages by the engine control unit via the high and low heat output relays, depending on demand and engine load.

To activate the heating element, the following conditions must be met:

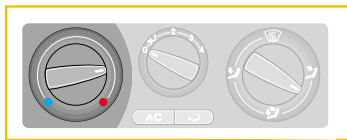

Position of the rotary push-button between 80%-100% heat output

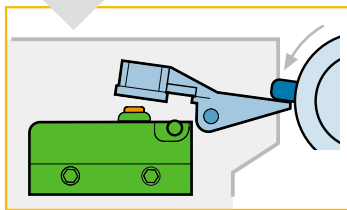

Contact switch opened as of 80% heating output

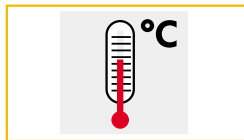
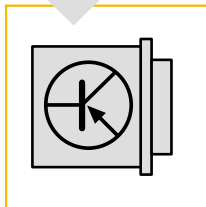

Intake air less than 19°C / coolant temperature less than 80°C

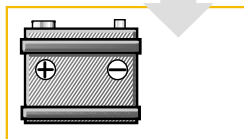

Battery voltage greater than 11 V

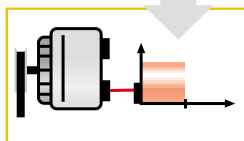

3-phase AC alternator load factor less than 55% (signal from terminal DF)

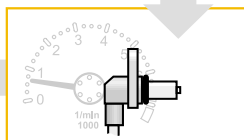

Engine speed greater than 450 rpm

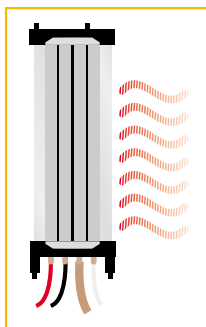

223_126



You will find detailed information regarding the additional heating element in Self-Study Programme No. 218 „The Lupo 3L TDI“.

The stop/start function







In Economy mode, the stop/start function of the Lupo 3L is activated in order to avoid unnecessary fuel consumption. For this purpose, the engine is shut off during stationary phases.

TDI

The pages marked with the TDI symbol explain the functions and engineering of the Lupo 3L

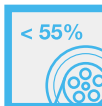

The following conditions must be met so that the engine stops automatically.

223_141a to l

- The selector lever is in position E. _____ 
- Economy mode is active. _____ 
- The brake pedal is held for 3 seconds. _____ 
- Brake pressure is above 4 bar. _____ 
- The ABS wheel speed sensors signal that the vehicle is stationary. _____ 
- Coolant temperature is above 17° C. _____ 
- The alternator load factor is below 55%. _____ 

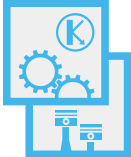

Vehicle operation can resume when the following conditions are met:

- The brake pedal is released. _____ 
- The gearbox control unit starts the engine. _____ 
- The gearbox control unit activates the clutch. _____ 
- The driver depresses the accelerator pedal and the vehicle accelerates. _____ 

Starter motor

The starter motor

The starter motor of the Lupo 3L has a control unit which controls the starting operation.

Basically, the starter motor equivalent is designed as a bendix-drive starting motor with planetary gear. The service life of the starter motor has been extended by the numerous starting cycles due to the STOP/START function. This was achieved by reinforcing the mechanical components of the starter motor and modifying the electrical control.

TDI

Mechanical reinforcements

- Brushes extended
- Meshing spring reinforced
- Engaging lever is carbon-fibre reinforced
- Starter sprocket gear widened.

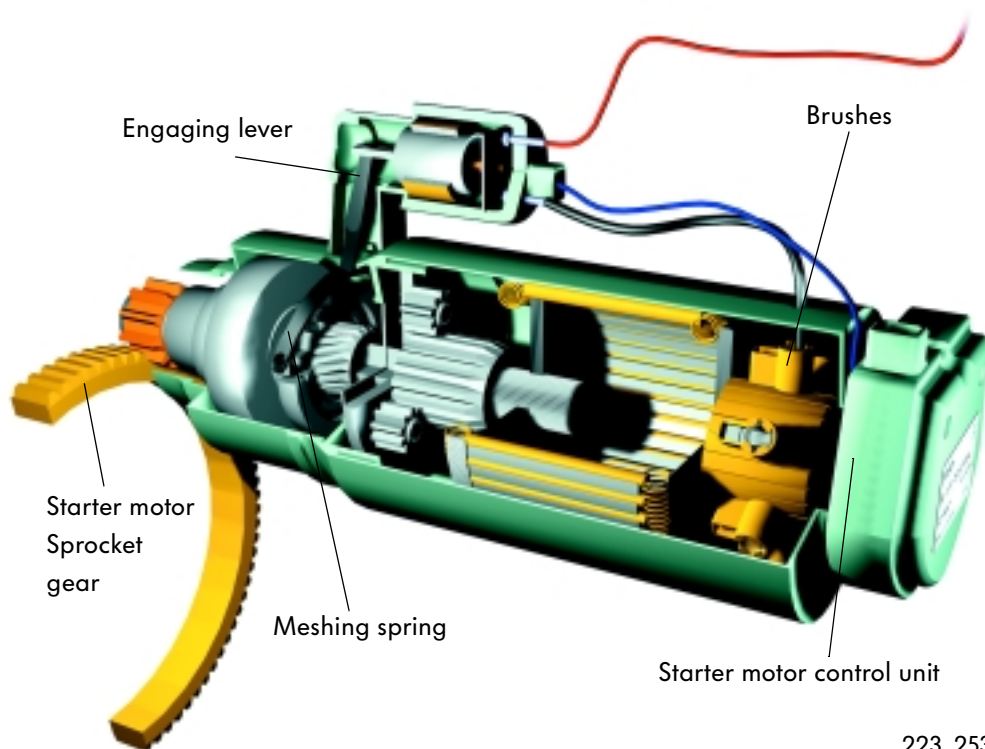

223_253

Electrical control

The starter motor control unit is mounted on the housing. It controls the meshing operation. Wear of the starter pinion and starter

sprocket gear is reduced by soft, time-controlled meshing of the starter pinion in the starter sprocket gear.



The starter motor and starter motor control unit can only be replaced together.

This is how it works:

The starting cycle is initiated by the gearbox control unit. For this purpose, the gearbox control unit activates the starter inhibitor relay. The relay switches the current to the starter motor control unit. The control unit regulates the current flow for the starter pinion meshing operation. The starting cycle is activated either by means of the STOP/START function, or in the conventional manner by turning the ignition key in the ignition switch.

TDI

Electrical circuit

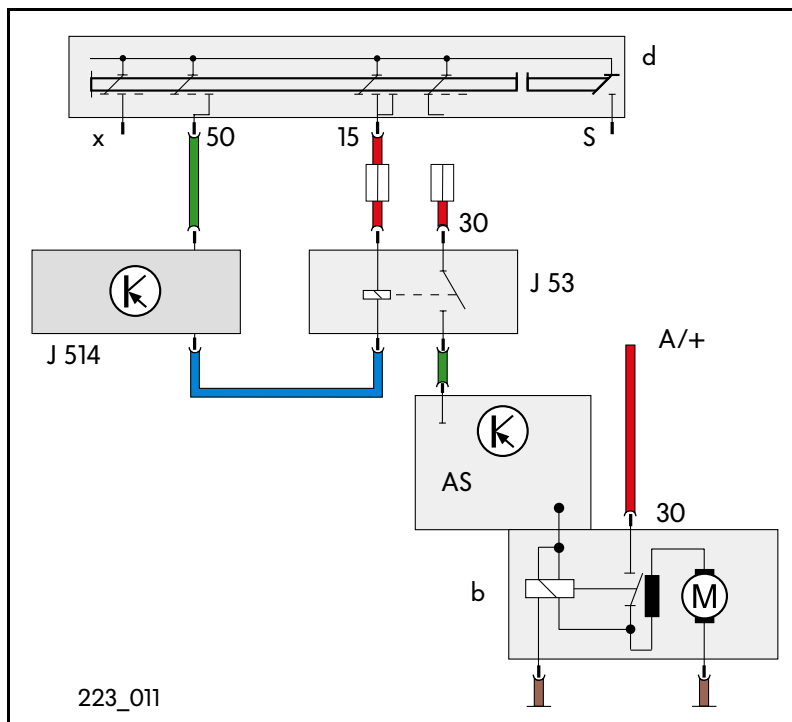

- A: Battery
- B: Starter motor
- D: Ignition switch
- J53: Starter motor relay
- J514: Electronic manual gearbox control unit
- AS: Starter motor control unit



223_011

Starter motor

TDI

Phase 1

In the first phase, the current rises. A magnetic field is built up in the pulling coil and the pulling armature picks up.

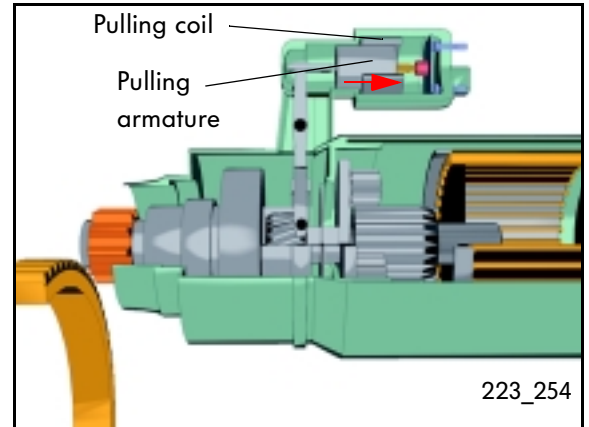

Phase 2

After the idle motion of the engaging lever has been overcome, the current flow from the control unit is reduced for approx. 10 ms until the starter pinion makes contact with the starter sprocket gear. This reduces the pre-engagement speed of the starter pinion by a factor of 4 and ensures soft pre-engagement which reduces starter pinion wear.

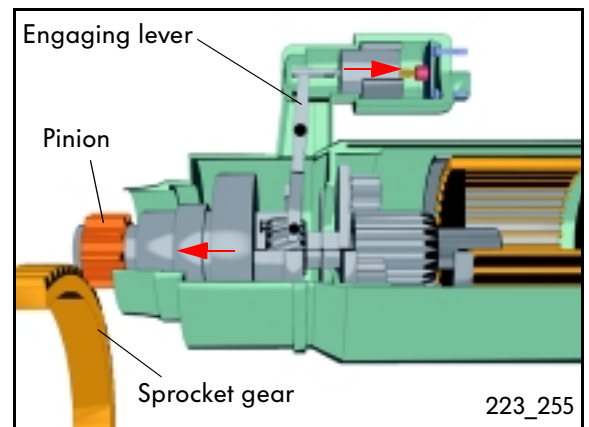

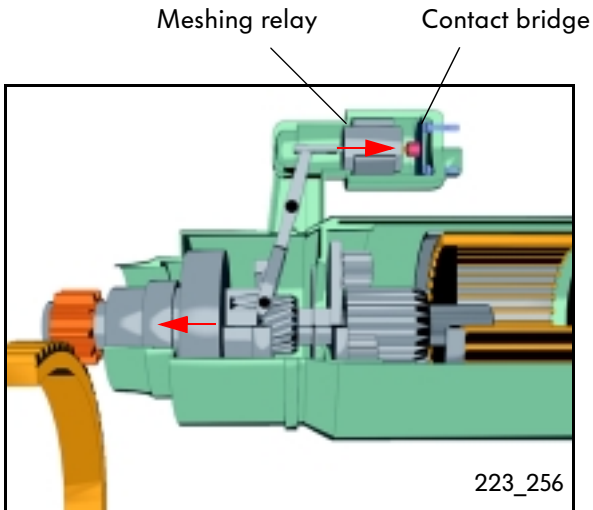

Phase 3

In the third phase, the current rises again. The starter pinion meshes with the sprocket gear at the same time.

Phase 4

The last phase is initiated by the closing of the contact bridge in the meshing relay. As a result, the starter motor starts up and turns the engine crankshaft via the sprocket gear. The holding current is maintained until the engine has started.



Current curve

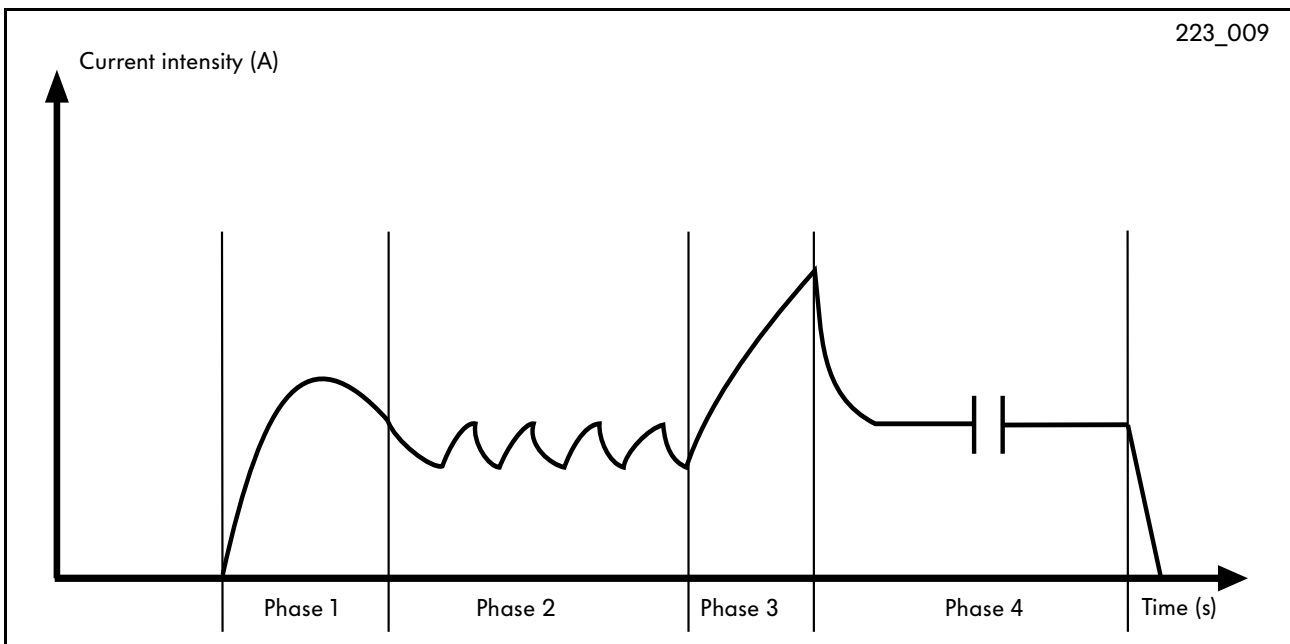

Engine management system

Engine starting safety concept

TDI

As already explained on page 4, the Lupo 3L has an electronic manual gearbox. The gearbox control unit computes the gear changes and controls the STOP/START function. To prevent uncontrolled movement of the vehicle during the starting operation, several conditions have to be observed when starting the engine.

The engine can only be started in the STOP and N positions of the selector lever.

In the STOP position of the selector lever.....

... the 1st gear or reverse gear is engaged in the gearbox.

To start the engine, the clutch must be opened or the gearbox engaged in the neutral position. Therefore, the foot brake must be pressed when starting the engine in order to prevent uncontrolled movement of the vehicle.



223_167

For this purpose, the gearbox control unit receives the "brake operated" signal from brake pedal switch F47 via the engine control unit.

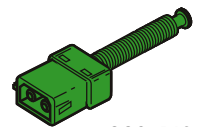

223_169

In selector lever position N.....

... the gearbox is in idling mode. To prevent the vehicle from rolling away, the handbrake should be securely applied.



223_168

Safety condition when starting in Economy mode

If the vehicle is in Economy mode, the engine is not started by the STOP/START function when the driver's door is open. This measure serves to prevent uncontrolled movement of the vehicle when the driver exits the vehicle.

(As long as the foot brake is operated, the driver can return to normal STOP/START operation by closing the door).

The gearbox control unit receives the "door open" or "door closed" signal from door contact switch F2.

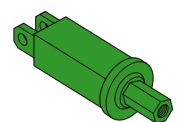

223_170

Acoustic signals

TDI

As an additional safety precaution, a gong signal sounds in the dash panel insert in order to alert the driver to the following situations:

- When the driver's door is opened when a drive position is selected and the engine is running. The signal ensures that the driver does not exit the vehicle while the engine is running and thus prevents uncontrolled movement of the vehicle. As the clutch is engaged up to the slip point, the vehicle displays a tendency to "creep".
- When the engine is shut down by the STOP/START function and the driver's door is opened. The signal indicates that the engine will not be started in the usual manner by the STOP/START function when the foot brake is released. The engine must be started in the STOP or N position of the selector lever.
- When the vehicle is being driven with the handbrake applied.
- When the vehicle is held on gradients for a lengthy period of time while a drive position is selected. In this situation, the clutch slips, because it is engaged as far as the slip point in order to ensure a good response to gear changes. The clutch is opened when it becomes too hot due to overloading. The signal alerts the driver to the danger before the clutch opens and the vehicle rolls away.
- If gearshifts are activated very frequently while driving. The signal indicates that an unnecessarily large amount of fuel is being consumed and that the hydraulic system is under heavy strain.



Engine management

Idling speed control

TDI

To save fuel, the idling speed of the 1.2-litre TDI engine is regulated differently when the vehicle is travelling and when it is stationary.

When the vehicle is stationary, the idling speed is reduced to 850 rpm for comfort reasons.

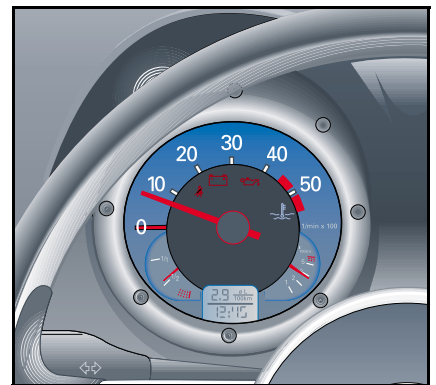

223_204

When the vehicle is travelling, the idling speed is reduced to 770 rpm. This saves fuel and reduces pollutant emissions.

For idling speed control, the engine control unit differentiates between a travelling vehicle and a stationary vehicle at a road speed of >13 kph.

The engine control unit receives information on vehicle speed from road speed sender G22 via the control unit for the dash panel insert.

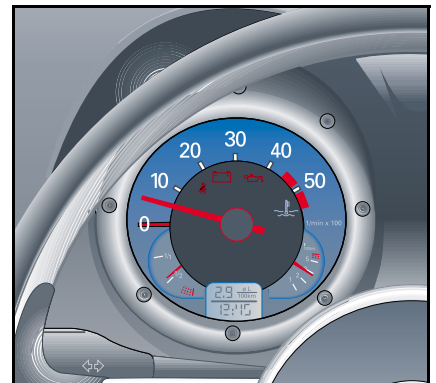







223_205





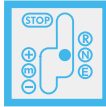

Notes on tow starting and towing.

TDI

The following conditions must be met in order to tow start the Lupo 3L:

- Switch ignition on. _____ 
- The battery must be charged. The gearbox has an electro-hydraulic system. It operates only when sufficient battery charge is available. _____ 
- Engage the selector lever in the **N** position. _____ 
- Keep tow starting speed above 6 kph so that the selector lever lock is not active. _____ 
- When towing speed is reached, shift the selector lever into position **E**. _____ 
- Deactivate the Eco mode so that the engine does not shut off automatic after stopping. _____ 

The following conditions must be met in order to tow the Lupo 3L:

- The battery must be charged. _____ 
- Engage the selector lever in the **N** position. _____ 
- If the gearbox is not in neutral, then the vehicle must be towed with front axle raised. _____ 
- Do not exceed a towing speed of 50 kph. _____ 



Self-diagnosis

The self-diagnosis procedure is started with address word 01 „Engine electronics“. In self-diagnosis mode, the diesel direct injection system control unit provides the following functions and is able to communicate with the Vehicle diagnostic, testing and information system VAS 5051:

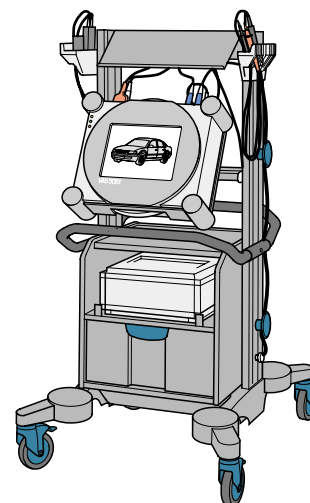

223_159

Function	Address word
Interrogate control unit version	01
Interrogate fault memory	02
Actuator diagnosis	03
Basic setting	04
Clear fault memory	05
End of output	06
Encode control unit	07
Read data block	08



Please follow the relevant instructions in the Workshop Manual.

Engine oil

As of model year 2000, new service engine oils are required for engines with "Long Life Service" and for the diesel engines with unit injector system. These engine oils have the specification 0W30 and therefore have a lower viscosity than the engine oils used previously. Further

advantages are their higher thermal load tolerance and enhanced cleaning properties. To account for the high loads produced by driving the unit injector elements, the oils for the diesel engines with unit injector system also have high shear strength.

The engine oil standards for the 1.2l TDI and the 1.4l TDI engines are different.

The 1.2l TDI engine must be filled with the oil conforming to VW standard 50600. This oil is also used in the diesel engines with "Long Life Service". It has special idling properties and therefore helps to improve fuel economy.

VW 50600 for the 1.2l TDI engine (Lupo 3L)

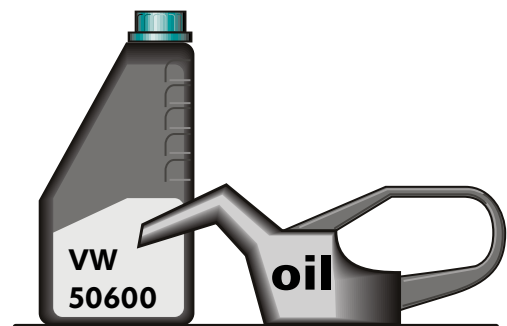

223_101

The 1.4l TDI engine is filled with oil suitable for engines with unit injector. This oil meets VW standard 50501.

VW 50501 for the 1.4l TDI engine

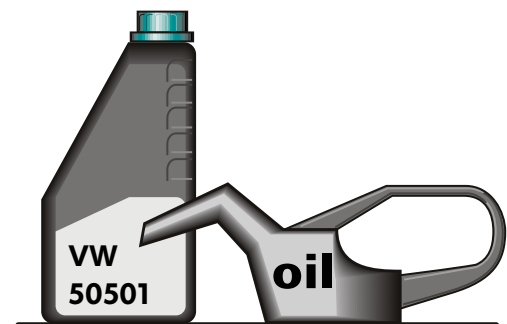

223_101



Also refer to the notes in the repair literature and Self-Study Programme No. 224 „Maintenance interval extension“.

Service

Special tools

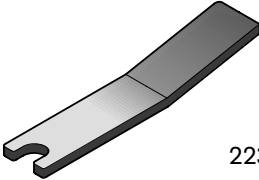
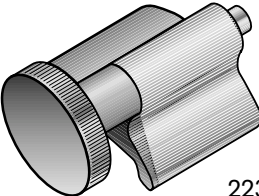
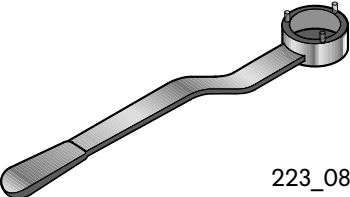
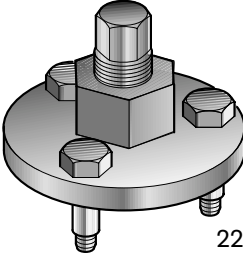
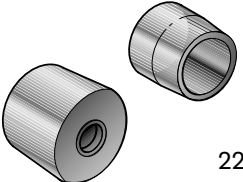
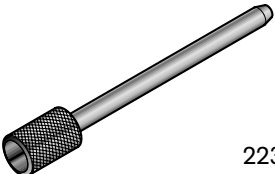
Designation	Tool	Use
T 10008 marking plate	 223_058	For fixing the hydraulic toothed belt tensioner in place when installing and removing the toothed belt.
T 10050 crankshaft stop	 223_092	For fixing the crankshaft to the crankshaft gear wheel when adjusting the port timing.
T 10051 counter-holder for camshaft gear wheel	 223_089	For installing the camshaft gear wheel.
T 10052 pulling-off device for camshaft gear wheel	 223_088	For detaching the camshaft gear wheel from the camshaft taper.
T 10053 assembly fixture for crankshaft sealing ring	 223_087	Guide sleeve and compression sleeve for fitting the crankshaft sealing ring.
T10060 drift	 223_162	For arresting the tensioning device for the ribbed V-belt

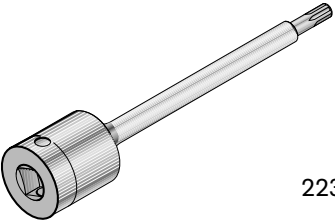
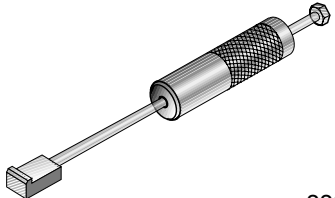
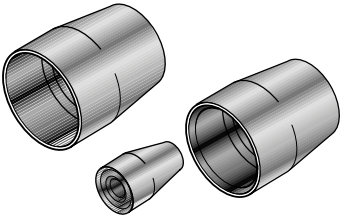
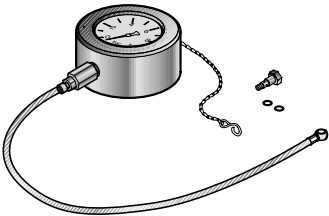
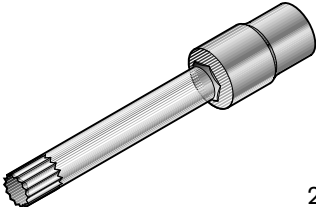

Special tools

Designation	tool	Use
T 10054 alignment bracket set	 <p>223_084</p>	For fitting the fastening bolt of the clamping block of the unit injector.
T 10055 pulling-off device for unit injector element	 <p>223_091</p>	For pulling the unit injector out of the cylinder head.
T 10056 assembly sleeve for O-rings	 <p>223_090</p>	For fitting the O-rings of the unit injector.
V.A.S. 5187 pressure gauge	 <p>223_086</p>	For checking the fuel supply pressure on the fuel pump.
T10061 socket insert	 <p>223_161</p>	For undoing and tightening the cylinder head nut as well as the fastening bolt for the counterweight



Test your knowledge

1. The balancing shaft has the following tasks:

- a) It reduces the vibrations of the engine crank drive and ensures that the engine runs smoothly.
- b) It compensates for fluctuation in engine idling speed.
- c) It drives the vacuum pump.

2. The tension bolts in the 1.2l TDI engine...

- a) ... are steel pins which are used to bolt the aluminium cylinder block, the cylinder head and the crankshaft bearing cover.
- b) ... are steel pins with which the camshaft bearings are anchored in the aluminium cylinder head.
- c) ... are securely glued into the cylinder block and cannot be replaced.

3. The exhaust gases which are recirculated in the intake manifold are cooled in order...

- a) ... to reduce the thermal load on the catalytic converter.
- b) ... to reduce the combustion temperature.
- c) ... to reduce nitrogen oxide formation.

4. In what state does the electrical fuel pump run continuously?

- a) As soon as the engine turns.
- b) As soon as the engine has started.
- c) As soon as idling speed is reached.



5. What statement applies to the charge pressure control system for the 1.4l TDI engine?

- a) The charge pressure control solenoid valve is activated by the engine control unit.
- b) The engine has a variable turbine geometry.
- c) The control pressure for actuating the charge pressure control valve is generated from the atmospheric pressure and vacuum.

6. What is the task of the starter motor control unit on the starter of the 1.2l TDI engine?

- a) It controls the starting operation and thus minimises starter pinion wear.
- b) It automatically initiates the starting cycle and shuts off the engine as required.
- c) It serves as an anti-theft device and is activated by the engine control unit for this purpose.

7. In what selector lever position can the 1.2l TDI engine in the Lupo 3L be started?

- a) In selector lever position N.
- b) In selector lever position STOP.
- c) In any selector lever position.



Solutions

1.) a

2.) a, c

3.) b, c

4.) a

5.) a, c

6.) a

7.) a, b



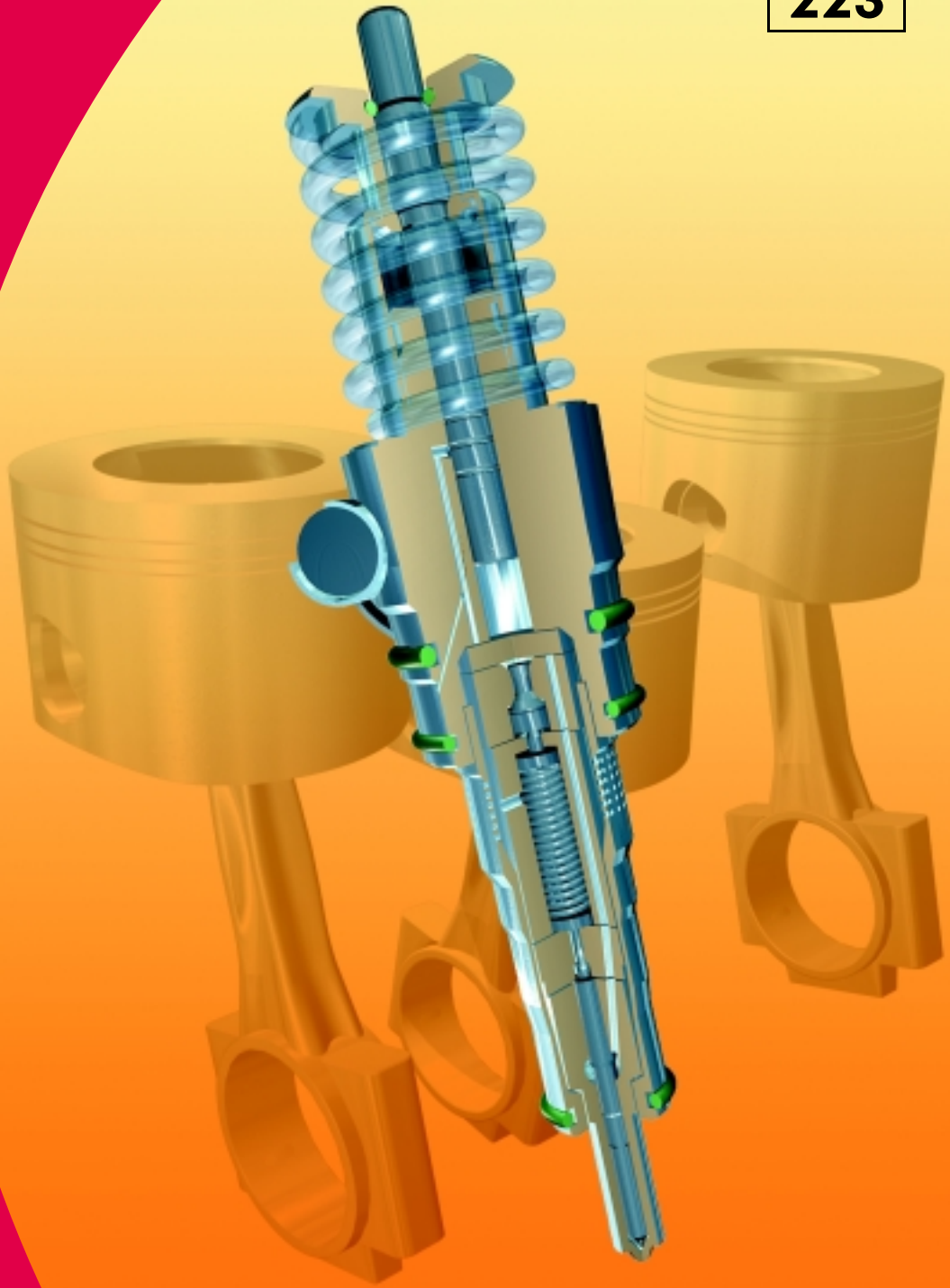

For internal use only © VOLKSWAGEN AG, Wolfsburg

All rights reserved. Technical specifications subject to change without notice.

040.2810.42.20 Technical status: 06/00

 This paper is produced from non-chlorine-bleached pulp.